



**ALD LightingSolutions Ltd**  
Unit 4 The Birch Estate, Eastbourne  
T. +44 (01323) 430047  
E. [ledscape@aldlightingsolutions.co.uk](mailto:ledscape@aldlightingsolutions.co.uk)

Catalogue V1

LEDSCAPE  
THE POWER OF LIGHT

[www.ledscape.co.uk](http://www.ledscape.co.uk)

LEDSCAPE®  
THE POWER OF LIGHT

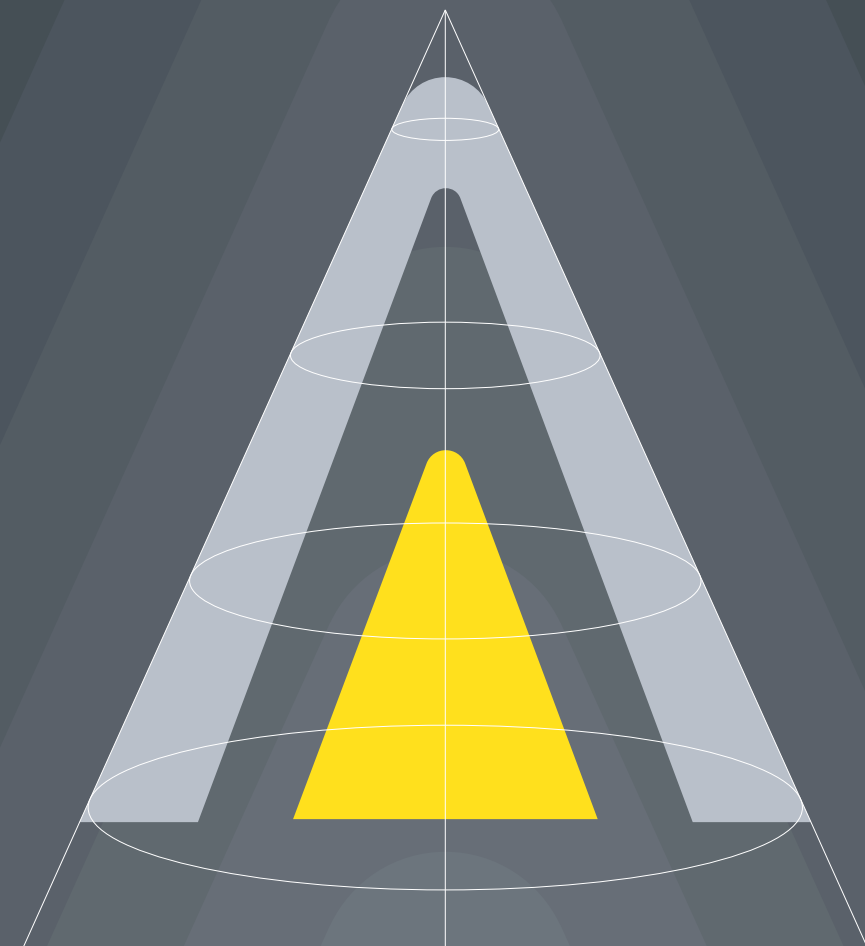

# LEDSCAPE®

THE POWER OF LIGHT

## THE POWER OF LIGHT

**LEDSCAPE** is a joint venture between a group of experienced lighting professionals and one of the largest manufacturers of street and exterior lighting in China.

The **LEDSCAPE** senior management team have over 60 years combined experience of innovation and excellence in lighting, ensuring that we provide our customers with high quality, high performance, environmentally friendly and sustainable solutions.

From our 270,000 sq ft production facility we utilise the latest technology and manufacturing techniques to provide a comprehensive range of products to meet the demands of the modern, environmentally demanding world.

Our UK distribution centre is ideally located to service the whole of the UK and Ireland, and also into mainland Europe and beyond, backed up with first class customer service and technical support.

**LEDSCAPE** is dedicated to reducing the harmful effects of artificial light and light pollution on our ecosystems and environment. We are committed to not offering products with colour temperatures above 4000K, with an ongoing desire to educate about the benefits of warmer colour temperatures.



# About LEDSCAPE

Utilising advanced management processes and with a commitment to product development and sustainability, the **LEDSCAPE** 270,000 sq ft production facility is dedicated to producing the highest quality exterior and architectural lighting products.

First class manufacturing techniques, where all steps are completed in-house, and meticulous attention to detail ensure the highest quality for every single production batch.

Full and stringent quality control at all steps of the manufacturing process, including full performance and safety testing in our advanced laboratory, ensure product longevity once placed into the market.

The desire to achieve the highest quality is highlighted by our commitment to ensuring compliance to the latest international standards and regulations, which is verified by internationally recognised third party laboratories.



## Surge Protective Device

The SPD protects the electronic components from damage caused by voltage surges, spikes and lightning, thus ensuring lifespan.

LED lighting is different to the conventional discharge light sources and are designed to work under low voltage conditions, so they are particularly sensitive to sudden changes in the supply voltage. In street lighting, different kinds of overvoltage can occur so it is important to use protective devices to ensure continued operation of the luminaires.

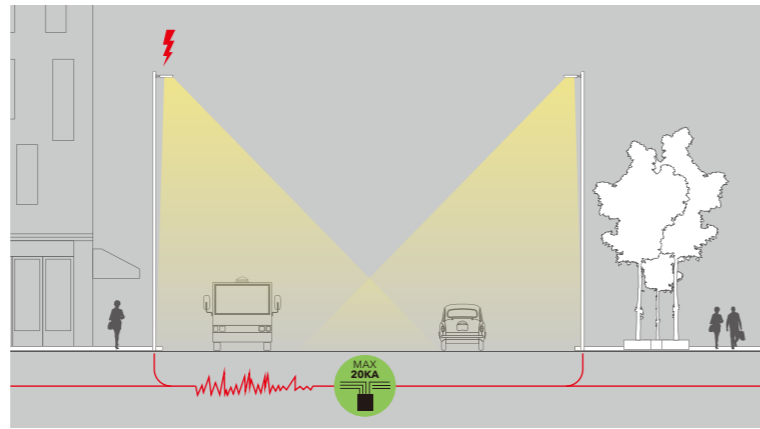

### How Does it Works

- Connected in series.
- Able to absorb overcurrent peaks up to 20KA.
- Absorbs both transient and permanent overvoltages between phase, neutral and earth, and diverts the current to earth.
- Even at the end of its lifespan, the SPD disconnects the luminaire to ensure it does not remain unprotected to overvoltages.
- Replacing the SPD at the end of its life is a process as simple as replacing a fuse.

## Beam Lens Optics

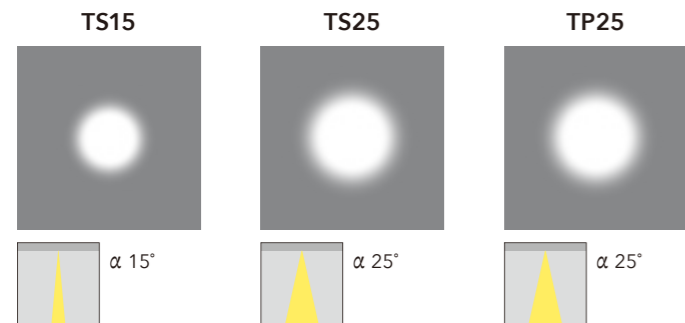

## Symmetric Lens Optics

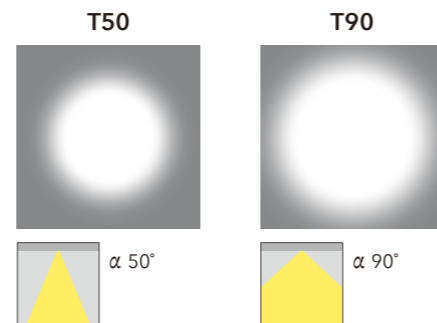

## Lens Application

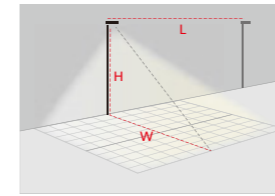

**Asymmetric Lens**  
H = Installation height  
W = Width of area  
L = Distance between poles

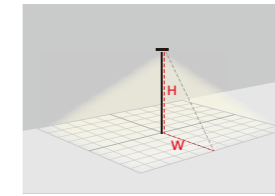

**Symmetric Lens**  
H = Installation height  
W = Width of area

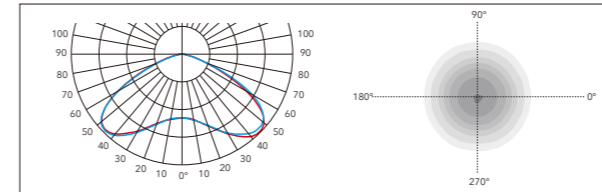

**T1 / T1D**  
Street optic for intense vehicle traffic, urban and suburban areas.  
W = 3H (4 in 1) / D (6 in 1)

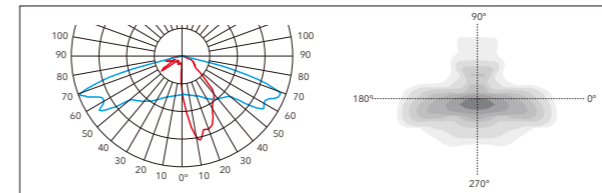

**T2A / T2D**  
Optic for residential streets and bicycle lanes.  
W = 0.7H L = 5H A (4 in 1) / D (6 in 1)

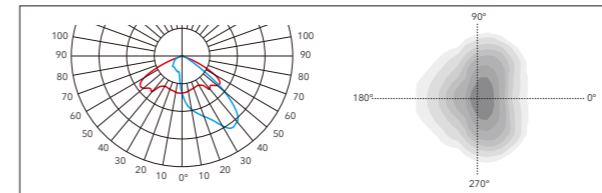

**T2W**  
Optic for residential streets and parks and walkways etc.  
W = 1H L = 3.5H W (4 in 1)

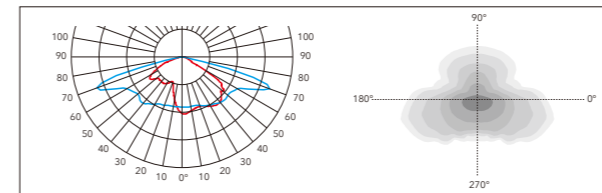

**T3A / T3D**  
Street optic for intense vehicle traffic, urban and suburban areas.  
W = 1H L = 4H A (4 in 1) / D (6 in 1)

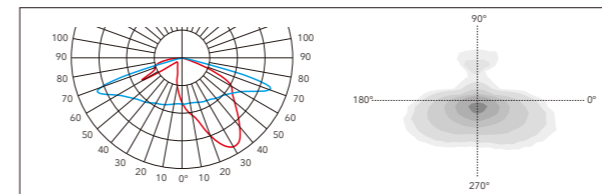

**T3M / T3N**  
Street optic for intense vehicle traffic, urban and suburban areas.  
W = 1H L = 4H M (4 in 1) / N (6 in 1)

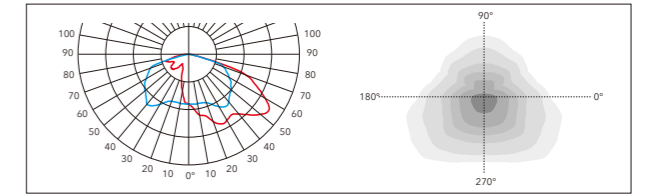

**T4A / T4D**  
Asymmetric light distribution for large areas.  
W = 1.2H L = 3H A (4 in 1) / D (6 in 1)

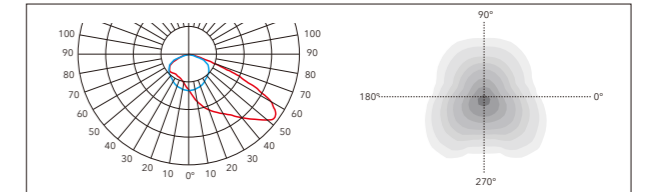

**T5A**  
Asymmetric light distribution for large areas.  
W = 1.5H L = 2.75H A (4 in 1)

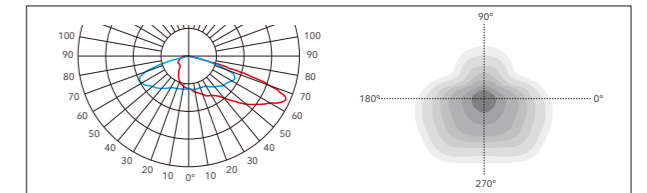

**T6A / TM6A18 / TM6A66**  
Comfort optic for squares and pedestrian urban areas.  
W = 1.5H L = 4.5H 6A (4 in 1) / 6A18 (18 in 1) / 6A66 (66 in 1)

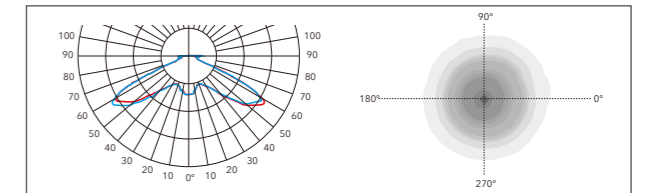

**T32B**  
Street optic for intense vehicle traffic, urban and suburban areas.  
W = 3H (32 in 1)

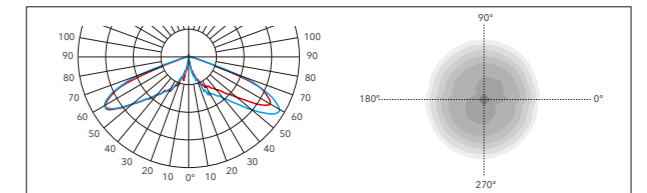

**TM1T18**  
Street optic for intense vehicle traffic, urban and suburban areas.  
W = 3H (18 in 1)

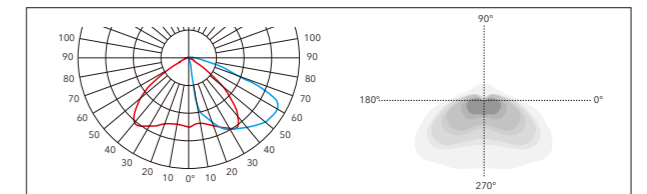

**TM3A18**  
Comfort optic for squares and pedestrian urban areas.  
W = 1H L = 3H (18 in 1)

Depending on the requirements, there are various intelligent control options available to suit a wide range of applications, from controlling individual luminaires to grouping complete installations. Smart control options include the following four configurations:

1. Middle of the Night
2. NEMA Socket
3. DALI Control
4. DMX Control

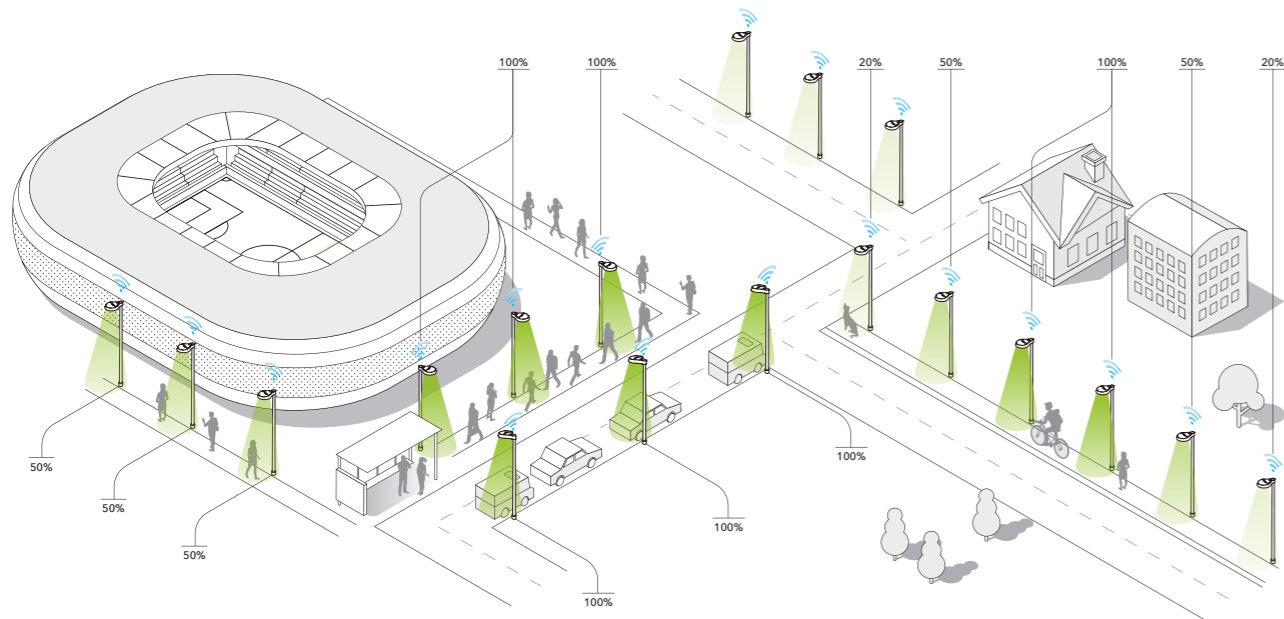

## Middle of the Night

Utilising special control systems, the luminaires can be programmed to dim to a pre-set level during the night when the area is less occupied, and return to full output when required.

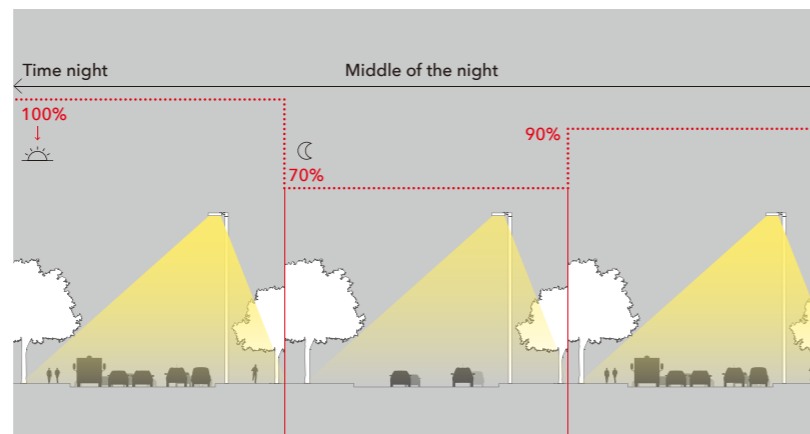

Example with Middle of the Night profile with Street

## NEMA Socket

A variety of products are available with NEMA sockets to allow a wide range of sensors and controls to be incorporated into the luminaire, allowing smart control and integration with lighting management systems.



## DALI Control

DALI drivers are provided as standard in all streetlights and available in a wide variety of additional products throughout the range. The benefit of DALI technology is that each luminaire has an independent address which can be used for precise dimming and control of single or multiple luminaires via a DALI control system.

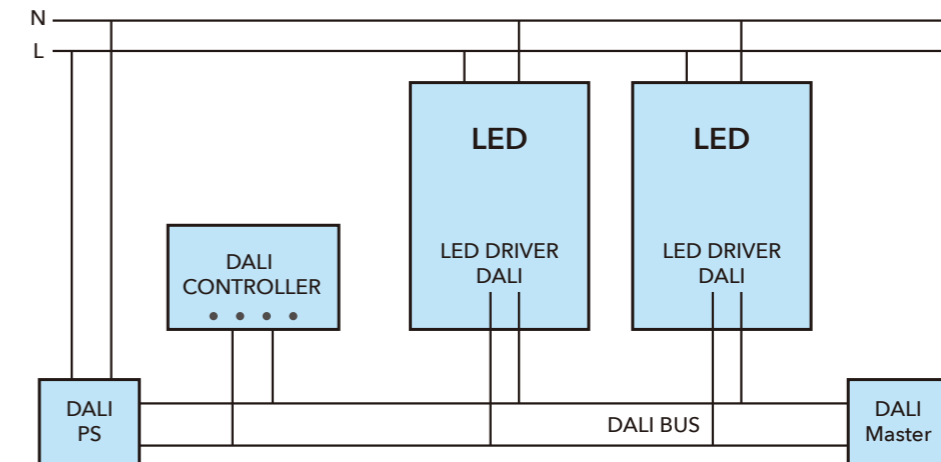

## DMX Control

DMX control has become very popular in architectural lighting as it allows centralised management of the lighting functions. DMX allows control of both single colour and RGBW luminaires to create bespoke lighting scenes to quickly change the ambience and to highlight structures and building facades.



Globally, light pollution has increased by at least 49% over the last 25 years. The light pollution produced by street lamps, advertising boards, flood lights and our homes is so bad that 80% of the world's population lives in the haze of a perpetual glow in the hours of darkness.

The reliable rhythm of night and day gives plants and animals signals for natural cycles of feeding, mating, migrating and navigating. Humans are altering this natural rhythm by flooding the world with artificial light. The impacts of light pollution spill into almost every ecosystem.



**Mammals - since 69% of mammals are nocturnal, artificial light can cause a variety of issues:**

- Less time looking for food due to reduced darkness.
- Some mammals that use darkness as cover would be more vulnerable to predators.
- Reproductive cycles are affected.



**Birds that migrate or hunt at night navigate by moonlight and starlight, artificial lighting means birds:**

- Migrating too early or too late, missing ideal conditions nesting, foraging and other behaviours.
- Colliding with needlessly illuminated buildings and towers.



**Bats have adapted to a life in darkness. Artificial light is:**

- Affecting leaving & returning to roosts.
- Disrupting communication and foraging routes.



**About half of insect species are nocturnal, meaning artificial light has a big impact on their life cycles:**

- Some insects are drawn to outdoor lights and it is estimated that 1/3 of those insects die by the morning, either from exhaustion or predators.
- Artificial light affects mating, reproduction and feeding habits.



**Humans are also affected by artificial light:**

- Melatonin levels are affected, altering the natural circadian rhythm and disrupting sleep patterns.
- Exposure to artificial light at night has also been linked to diabetes, mood disorders and increased risk of some types of cancer.

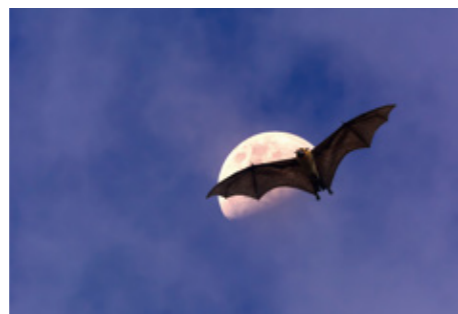

Artificial 'sky glow' can now be detected along 22% of the world's shorelines. That figure is expected to increase further as human populations along coasts more than double by 2060.



**Fish, despite living underwater, also face issues with artificial lighting:**

- Melatonin levels are suppressed so sleeping and reproductive patterns are disrupted.
- Eggs do not hatch in a timely manner or at all.



**Sea turtles live in the ocean but lay their eggs on the beach:**

- Nesting behaviour is affected by artificial light.
- Newly hatched marine turtles find the sea by detecting the bright horizon over the ocean, while artificial light draws them away from the water.



**Coral reproduction is affected by artificial light:**

- Many species of coral reproduce on a single night of the year in a process called mass coral spawning to maximise reproductive success. The timing of the spawning is synchronised with and triggered by the light of the moon, though artificial light is believed to reduce the effectiveness of this process.

## What can we do?

- Avoid illuminating areas they rest, forage in or travel through.
- Illuminate only what you really need and keep intensity low.
- Choose warmer colour temperatures which are less disturbing to local ecosystems.



## What can LEDSCAPE do?

- 1. Shielding** - using the right reflectors and optics can distribute light in the correct areas and even achieve a ULOR as low as 0%.
- 2. Colour temperature** - warmer colour temperatures minimise disruption to nocturnal ecosystems and create comfortable environments.
- 3. Control systems** - controls ensure artificial light is only used exactly when needed, saving energy along with reducing the ecological impacts.

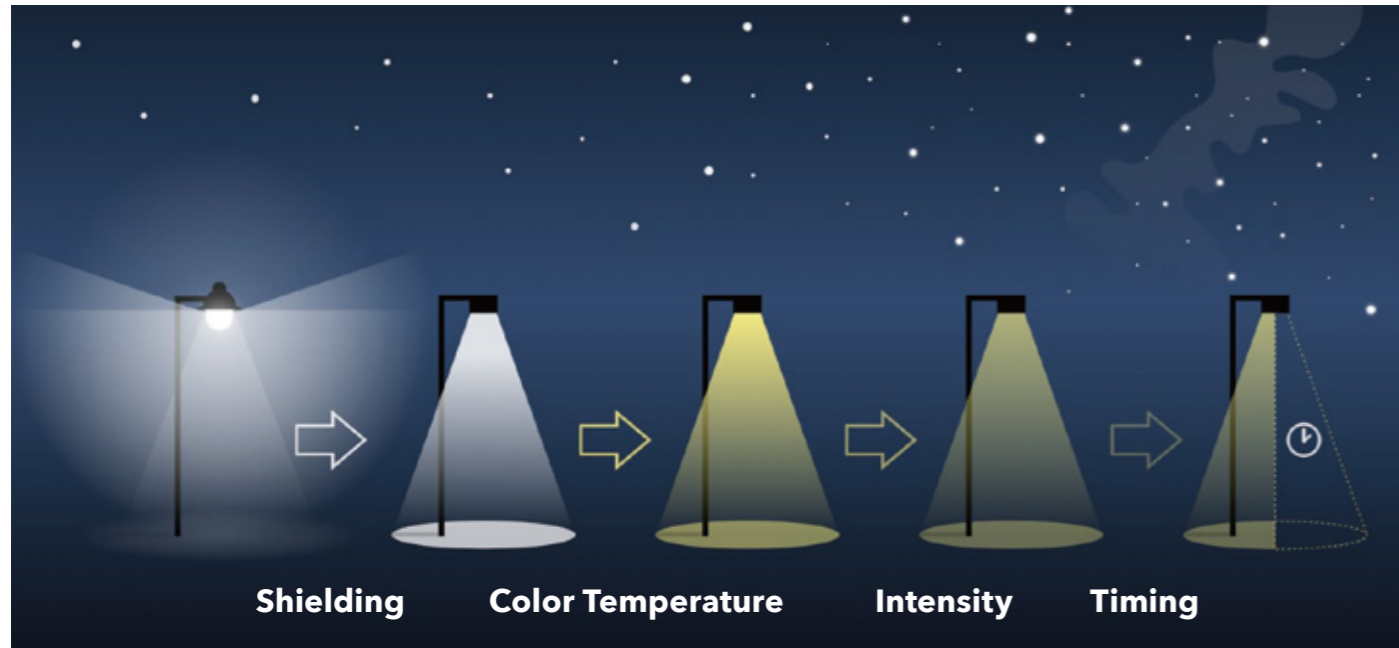

## ENVIRO Dual Colour Temperature Technology

LED chips create the perfect balance of lighting at night, providing a sense of security and wellbeing for people whilst conserving energy and protecting ecosystems.

ENVIRO dual CCT LEDs adjust and mix light from both warm and cool colours.

Cooler LEDs dim when night falls and only increase when occupancy and traffic levels rise in the morning, leaving warmer LEDs on throughout the night.

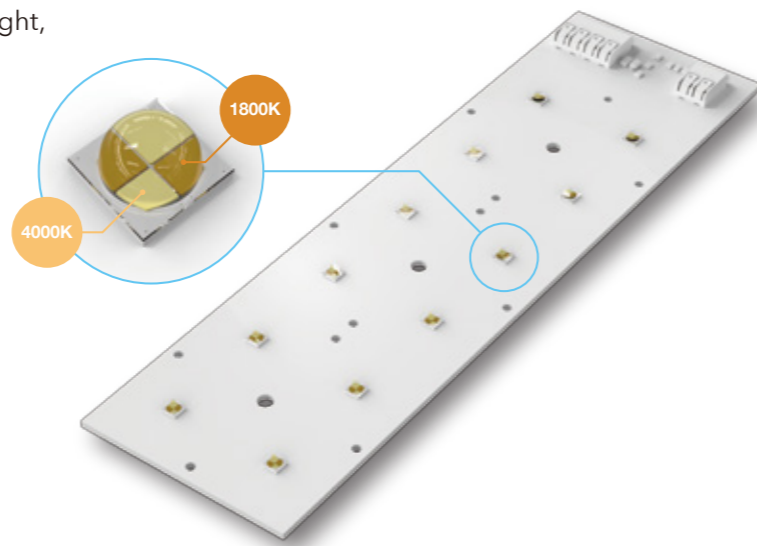

## ENVIRO Intelligent Dimming Driver

The LED driver used within the ENVIRO range of luminaires is programmable with self-adapting functionality, which can automatically adjust the dimming curve based on the previous days on/off timings to ensure optimum operation all year round.





**ENVIRO LIGHTING** 01  
P16-19



**STREET LIGHTING** 02  
P20-35



**PEDESTRIAN LIGHT** 03  
P36-61



**MAST LIGHTING** 04  
P62-67



**TRADITIONAL** 05  
P68-79



**FLOODLIGHTS** 06  
P80-103



**BOLLARDS** 07  
P104-117



**WALL LIGHTING** 08  
P118-137



**CEILING LIGHTS** 09  
P138-147

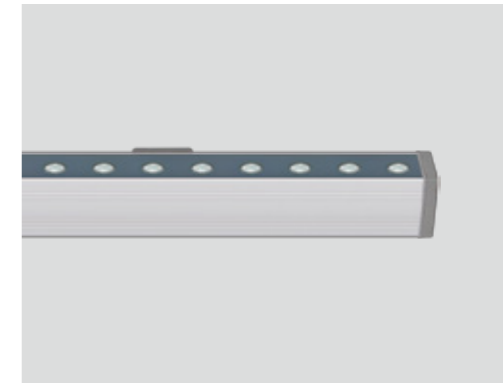

**WALL WASH** 10  
P148-153



**INGROUND** 11  
P154-167



**INDUSTRIAL** 12  
P168-173





A high-end streetlight and floodlight range utilising programmable ENVIRO technology to enable dimming during periods of low occupancy along with colour changing to warmer temperatures, reducing the negative effects of artificial light on the surrounding ecosystems.

- Die-cast aluminium housing with super white tempered glass. Attractive, modern design.
- Optical lenses with multiple distribution options, offering visual comfort and uniform light distribution.
- Intelligent and programmable driver allowing dimming and colour changing using dual colour temperature LED chips.
- Tool-free, easy open housing for fast installation and maintenance. Power automatically disconnects when housing is opened for additional safety.
- Adjustable mounting bracket on streetlight allows both horizontal and vertical pole mounting. Bracket suitable for Ø60mm pole diameter, bracket accessories available for other pole sizes.
- UV protected pure polyester powder coated housing offering high corrosion resistance.
- Suitable for use with a range of controls and remote management systems.
- All external screws are 304 stainless steel as standard.
- RAL9007, other RAL colours available on request.

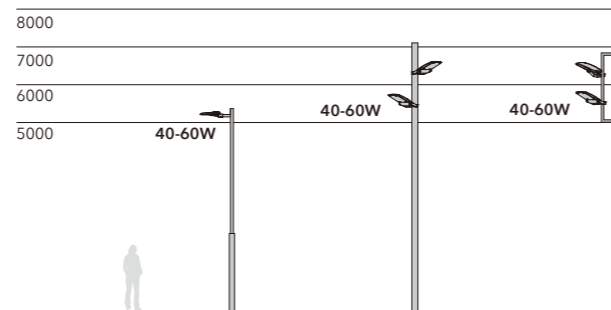
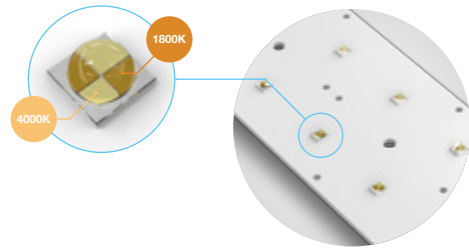

CODE	POWER	LED PCS	CCT	LUMEN OUTPUT	CRI	BEAM ANGLE	IP	IK	WARRANTY
URB-XS40-ENV-T3M	40W	24	1800-4000	4000-5400	>70	T3M	IP66	IK09	5 year
URB-XS40-ENV-T3A						T3A			
URB-XS40-ENV-T4A						T4A			
URB-XS60-ENV-T3N	60W	36	1800-4000	6000-8100	>70	T3N	IP66	IK09	5 year
URB-XS60-ENV-T3D						T3D			
URB-XS60-ENV-T4D						T4D			
URB-FL-XS40-ENV-T3A	40W	24	1800-4000	4000-4400	>70	T3A	IP66	IK08	5 year
URB-FL-XS40-ENV-T90						T90			
URB-FL-XS60-ENV-T3A	60W	24	1800-4000	5450-6000	>70	T3A	IP66	IK08	5 year
URB-FL-XS60-ENV-T90						T90			

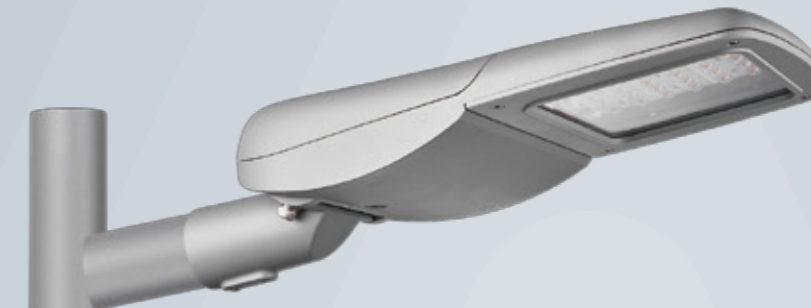

**URB-XS40-ENV**



**URB-FL-XS40-ENV**

A range of post top luminaires utilising programmable ENVIRO technology to enable dimming during periods of low occupancy along with colour changing to warmer temperatures, reducing the negative effects of artificial light on the surrounding ecosystems.

- Die-cast aluminium housing with super white tempered glass and polycarbonate reflector.
- Optical lens offering visual comfort and uniform light distribution.
- Intelligent and programmable driver allowing dimming and colour changing using dual colour temperature LED chips.
- Suitable for pole mounting on Ø60mm poles.
- UV protected pure polyester powder coated housing offering high corrosion resistance.
- Suitable for use with a range of controls and remote management systems.
- All external screws are 304 stainless steel as standard.
- SORA in RAL9007, LONDINIUM in RAL9005. Other RAL colours available on request.

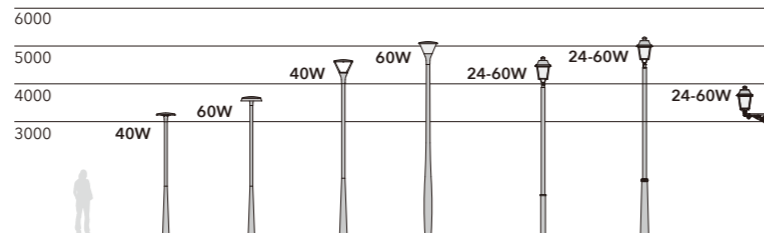
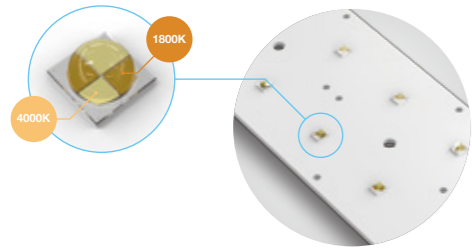

CODE	POWER	LED PCS	CCT	LUMEN OUTPUT	CRI	BEAM ANGLE	IP	IK	WARRANTY
SOR-T40-ENV-T1	40W	32	1800-4000	4000-4400	>70	T1	IP66	IK08	5 year
SOR-T55-ENV-T1	55W	32	1800-4000	5700-6300	>70	T1	IP66	IK08	5 year
SOR-V40-ENV-T1	40W	32	1800-4000	3960-4360	>70	T1	IP66	IK08	5 year
SOR-V40-ENV-T2W				T2W					
SOR-V55-ENV-T1	55W	32	1800-4000	5500-6000	>70	T1	IP66	IK08	5 year
SOR-V55-ENV-T2W				T2W					
LON-24-ENV-T1	24W	24	1800-4000	2180-2400	>70	T1	IP66	IK09	5 year
LON-40-ENV-T1D	40W	36	1800-4000	3270-3600	>70	T1D	IP66	IK09	5 year
LON-60-ENV-T1D	60W	36	1800-4000	4910-5400	>70	T1D	IP66	IK09	5 year



◀ SOR-V40-ENV

◀ SOR-T40-ENV

LON-24-ENV ▶

# STREET LIGHTING

A range of streetlights suitable for a variety of exterior applications such as residential roads, traffic routes, car parks, footpaths, cycle ways, and rail platforms.



**URBA**  
P22



**LIXUS**  
P26

Power	40-150W	40-150W
CCT	3000/4000	3000/4000
Lumen Output	5020-19730	5500-21520



**CANIC**  
P30



**PAX**  
P32

Power	40-120W	24-200W
CCT	3000/4000	3000/4000
Lumen Output	5200-15370	3120-28860



A practical, high-end LED street light with two size options and a power range of 40W to 150W. Ideal for use in urban areas as well as commercial applications, with a matching floodlight also available.

- Die-cast aluminium housing available in two sizes, with super white tempered glass. Attractive, modern design.
- Optical lenses with multiple distribution options, offering visual comfort and uniform light distribution.
- High quality LED chips and DALI driver as standard, with in-built surge protection up to 20KV.
- Tool-free, easy open housing for fast installation and maintenance. Power automatically disconnects when housing is opened for additional safety.
- Adjustable mounting bracket allows both horizontal and vertical pole mounting. Bracket suitable for Ø60mm pole diameter, bracket accessories available for other pole sizes.
- UV protected pure polyester powder coated housing offering high corrosion resistance.
- Suitable for use with a range of controls and remote management systems.
- All external screws are 304 stainless steel as standard.
- RAL9007, other RAL colours available on request.

#### Accessories

 Ø60-42mm Adapter



**URBA Range**  
Page 82

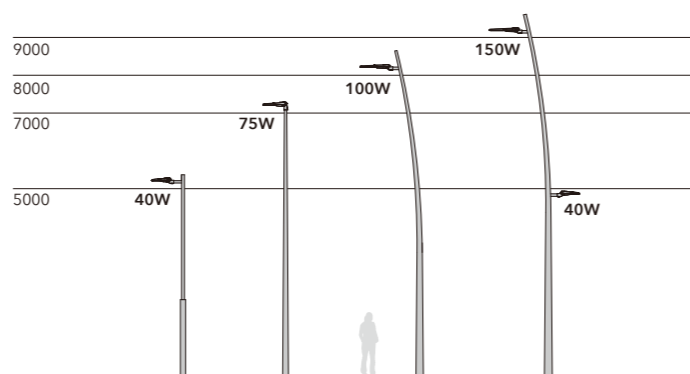

CODE	POWER	LED PCS	CCT	LUMEN OUTPUT	CRI	BEAM ANGLE	IP	IK	WARRANTY
URB-XS40-T3A	40W	24	3000/4000	5040/5290	>70	T3A	IP66	IK09	5 year
URB-XS40-T3M				5080/5330		T3M			
URB-XS40-T4A				5020/5270		T4A			
URB-XS75-T3D	75W	36	3000/4000	9390/9860	>70	T3D	IP66	IK09	5 year
URB-XS75-T3N				9420/9890		T3N			
URB-XS75-T4D				9370/9830		T4D			
URB-XS100-T3D	100W	36	3000/4000	12460/13080	>70	T3D	IP66	IK09	5 year
URB-XS100-T3N				12480/13100		T3N			
URB-XS100-T4D				12410/13030		T4D			
URB-S120-T3A	120W	48	3000/4000	15120/15870	>70	T3A	IP66	IK09	5 year
URB-S120-T3M				15180/15930		T3M			
URB-S120-T4A				15080/15830		T4A			
URB-S150-T3A	150W	48	3000/4000	18720/19650	>70	T3A	IP66	IK09	5 year
URB-S150-T3M				18790/19730		T3M			
URB-S150-T4A				18690/19620		T4A			



 **URB-S120**



**URB-XS40** 



IP66 control gear housing with cover support rod and automatic disconnection of power supply for additional safety.



Tool free release mechanism for easy maintenance.

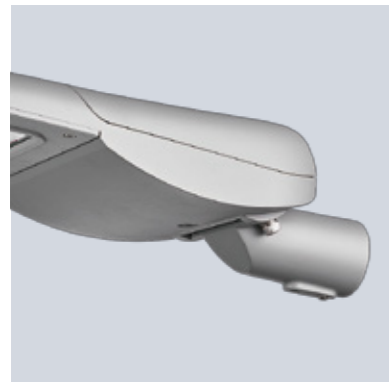

Horizontal or vertical pole mounting with Ø60mm spigot and Ø60-Ø42mm reducer accessory available.

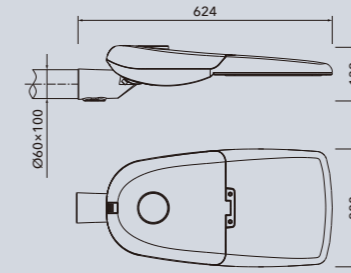

URB-S

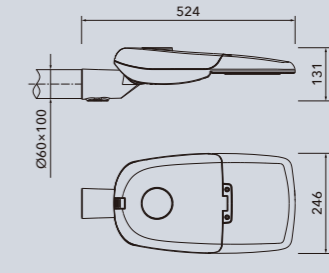

URB-XS



IK09 tempered glass and Zhaga standard PCB. Modular lenses also allow various light distributions to meet the requirements of different applications.



URBA STREET LIGHT



This high performance luminaire is available in two sizes with a power range of 40W to 150W. A modern and minimalist design ideal for urban and amenity applications.

- Die-cast aluminium housing available in two sizes, with super white tempered glass.
- Optical lenses with multiple distribution options, offering visual comfort and uniform light distribution.
- High quality LED chips and DALI driver as standard, with in-built surge protection up to 20KV.
- Tool-free, easy open housing for fast installation and maintenance. Power automatically disconnects when housing is opened for additional safety.
- Adjustable mounting bracket allows both horizontal and vertical pole mounting. Bracket suitable for Ø60mm pole diameter, bracket accessories available for other pole sizes.
- UV protected pure polyester powder coated housing offering high corrosion resistance.
- Suitable for use with a range of controls and remote management systems.
- All external screws are 304 stainless steel as standard.
- RAL9007, other RAL colours available on request.

**Accessories**

-  Ø76mm Fixing Arm
-  Ø60-42mm Adaptor

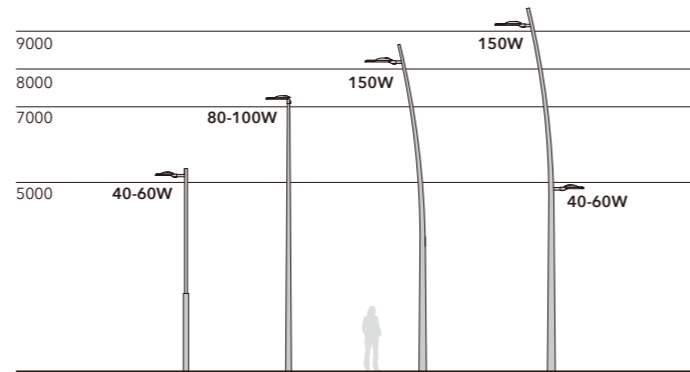

CODE	POWER	LED PCS	CCT	LUMEN OUTPUT	CRI	BEAM ANGLE	IP	IK	WARRANTY
LIX-S40-T2W	40W	24	3000/4000	5500/5840	>70	T2W	IP66	IK09	5 year
LIX-S40-T3M				5500/5840		T3M			
LIX-S60-T2W	60W	24	3000/4000	7870/8400	>70	T2W	IP66	IK09	5 year
LIX-S60-T3M				7870/8400		T3M			
LIX-S80-T2D	80W	36	3000/4000	10490/11300	>70	T2D	IP66	IK09	5 year
LIX-S80-T3D				10680/11480		T3D			
LIX-S80-T3N				10400/11240		T3N			
LIX-S100-T2D	100W	36	3000/4000	12960/13950	>70	T2D	IP66	IK09	5 year
LIX-S100-T3D				12390/14030		T3D			
LIX-S100-T3N				12890/13890		T3N			
LIX-L150-T3M	150W	48	3000/4000	20100/21520	>70	T3M	IP66	IK09	5 year
LIX-L150-T4A				19630/21120		T4A			
LIX-L150-T5A				19800/21150		T5A			



**LIX-L150**



**LIX-S40**



IP66 control gear housing with cover support rod and automatic disconnection of power supply for additional safety.



Simple, stylish design with tool free access for easy maintenance.



Horizontal or vertical pole mounting with Ø60mm spigot and Ø60-Ø42mm reducer accessory available.

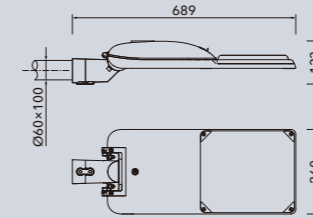

**LIX-L**

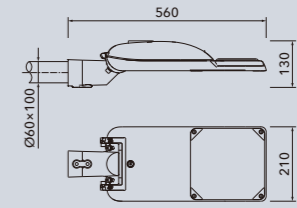

**LIX-S**



IK09 tempered glass and Zhaga standard PCB. Modular lenses also allow various light distributions to meet the requirements of different applications.

**LIXUS STREET LIGHT**



A stylish street light with a power range between 40W to 120W, ideally suited to urban environments and general area lighting.

- Die-cast aluminium housing with super white tempered glass.
- Optical lenses with multiple distribution options, offering visual comfort and uniform light distribution.
- High quality LED chips and DALI driver as standard, with in-built surge protection up to 20KV.
- Adjustable mounting bracket allows both horizontal and vertical pole mounting. Bracket suitable for Ø60mm pole diameter, bracket accessories available for other pole sizes.
- UV protected pure polyester powder coated housing offering high corrosion resistance.
- Suitable for use with a range of controls and remote management systems.
- All external screws are 304 stainless steel as standard.
- RAL9007, other RAL colours available on request.

### Accessories

Ø40mm Fixing Arm

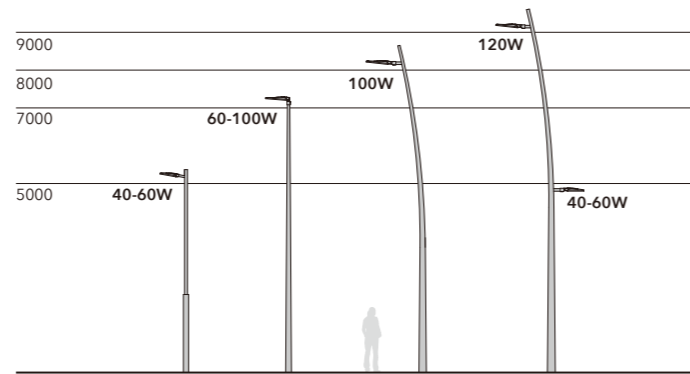

CODE	POWER	LED PCS	CCT	LUMEN OUTPUT	CRI	BEAM ANGLE	IP	IK	WARRANTY
CAN-S40-T2W	40W	16	3000/4000	5200/5600	>70	T2W	IP66	IK08	5 year
CAN-S40-T3A				5200/5600		T3A			
CAN-S40-T3M				7630/8180		T3M			
CAN-S60-T2W	60W	16	3000/4000	7580/8170	>70	T2W	IP66	IK08	5 year
CAN-S60-T3A				7580/8170		T3A			
CAN-S60-T3M				7870/8530		T3M			
CAN-M100-T3A	100W	32	3000/4000	12890/13720	>70	T3A	IP66	IK08	5 year
CAN-M100-T3M				12930/13810		T3M			
CAN-M120-T3A	120W	32	3000/4000	14410/15310	>70	T3A	IP66	IK08	5 year
CAN-M120-T3M				14470/15370		T3M			



**CAN-M120**



**CAN-S40**

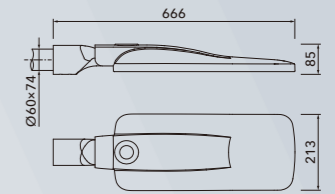

CAN-M

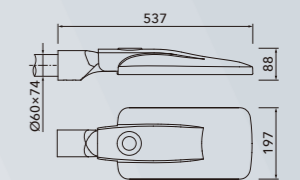

CAN-S





A comprehensive street light available in three sizes. Ideal for traffic routes and car parks due to its high output options, as well as footpaths and residential areas with the lower output options.

- Die-cast aluminium housing with super white tempered glass, available in three sizes.
- Optical lenses with multiple distribution options, offering visual comfort and uniform light distribution.
- High quality LED chips and DALI driver as standard, with in-built surge protection up to 20KV.
- Tool-free, easy open housing for fast installation and maintenance. Power automatically disconnects when housing is opened for additional safety, and the body can be completely detached.
- Adjustable mounting bracket allows both horizontal and vertical pole mounting. Bracket suitable for Ø60mm pole diameter, bracket accessories available for other pole sizes.
- UV protected pure polyester powder coated housing offering high corrosion resistance.
- Suitable for use with a range of controls and remote management systems.
- All external screws are 304 stainless steel as standard.
- RAL7016, other RAL colours available on request.

CODE	POWER	LED PCS	CCT	LUMEN OUTPUT	CRI	BEAM ANGLE	IP	IK	WARRANTY
PAX-S24-T2W	24W	16	3000/4000	3120/3360	>70	T2W	IP66	IK08	5 year
PAX-S24-T3A				3170/3410		T3A			
PAX-S24-T3M				3190/3440		T3M			
PAX-S40-T2W	40W	16	3000/4000	5200/5610	>70	T2W	IP66	IK08	5 year
PAX-S40-T3A				5250/5650		T3A			
PAX-S40-T3M				5360/5770		T3M			
PAX-S60-T2D	60W	24	3000/4000	7850/8440	>70	T2D	IP66	IK08	5 year
PAX-S60-T3D				8010/8610		T3D			
PAX-S60-T3N				7810/8410		T3N			
PAX-S80-T2D	80W	24	3000/4000	10420/11220	>70	T2D	IP66	IK08	5 year
PAX-S80-T3D				10560/11290		T3D			
PAX-S80-T3N				10400/11200		T3N			
PAX-M100-T2A	100W	32	3000/4000	13020/14030	>70	T2A	IP66	IK08	5 year
PAX-M100-T3A				13310/14230		T3A			
PAX-M100-T4A				13150/14160		T4A			
PAX-M150-T2A	150W	48	3000/4000	19720/21240	>70	T2A	IP66	IK08	5 year
PAX-M150-T3A				19680/21190		T3A			
PAX-M150-T4A				19540/21060		T4A			
PAX-L200-T2A	200W	72	3000/4000	26600/28600	>70	T2A	IP66	IK08	5 year
PAX-L200-T3A				26860/28860		T3A			
PAX-L200-T4A				26440/28460		T4A			
PAX-L200-T5A				26160/28180		T5A			





IP66 control gear housing with automatic disconnection of power supply for additional safety.



Easy installation and maintenance with a tool free housing that can be completely detached from the base.



Horizontal or vertical pole mounting with Ø60mm spigot - Ø76mm bracket and Ø60-Ø42mm reducer accessory available.



IK08 tempered glass and Zhaga standard PCB. Modular lenses also allow various light distributions to meet the requirements of different applications.

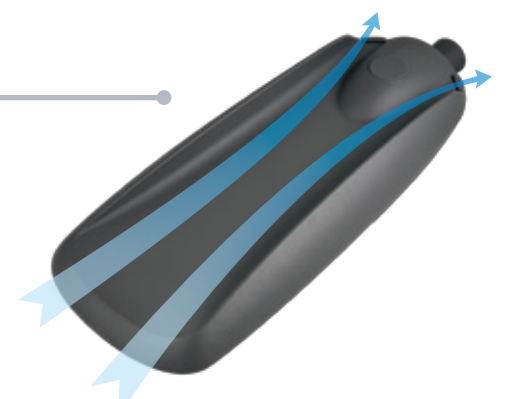
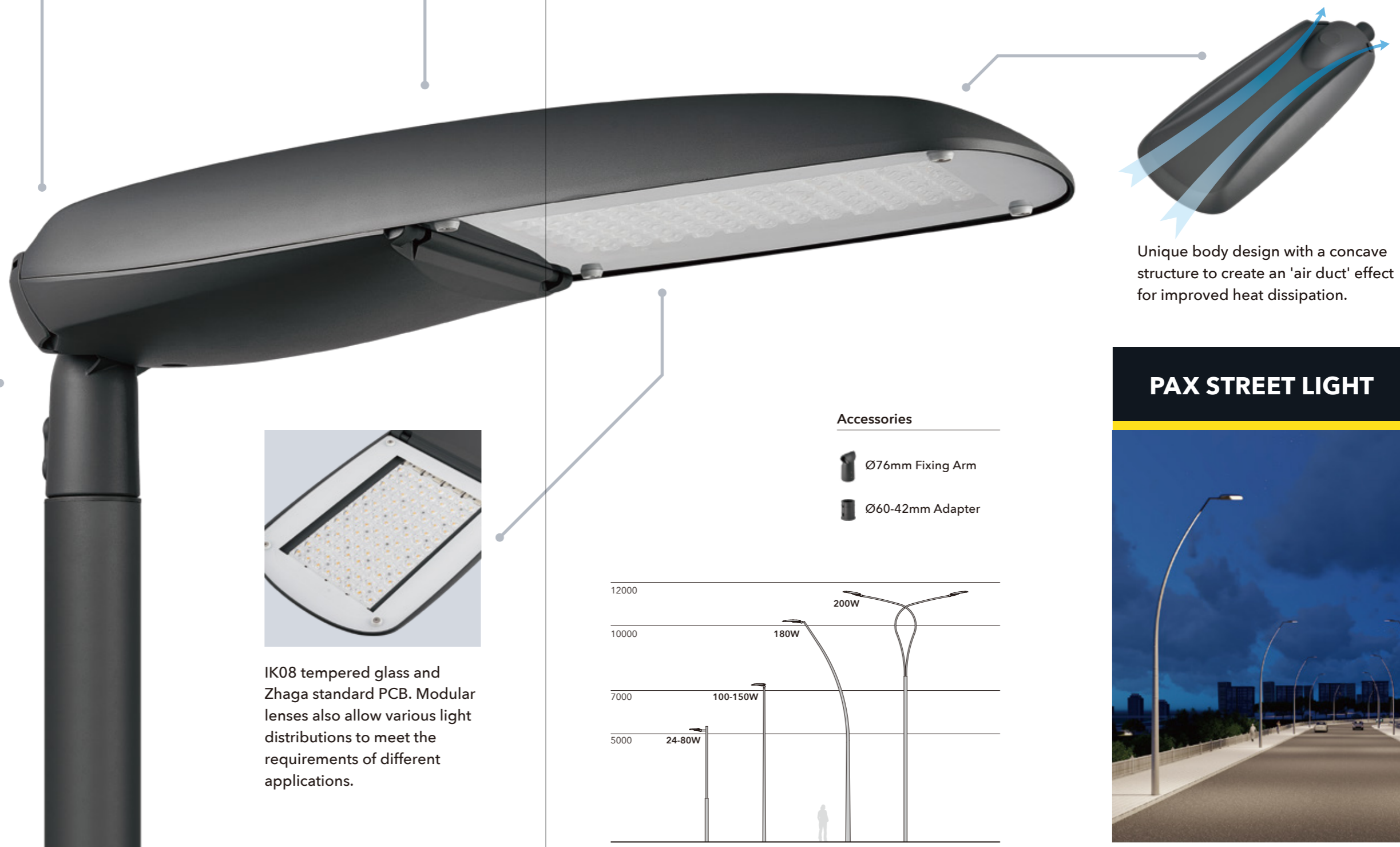
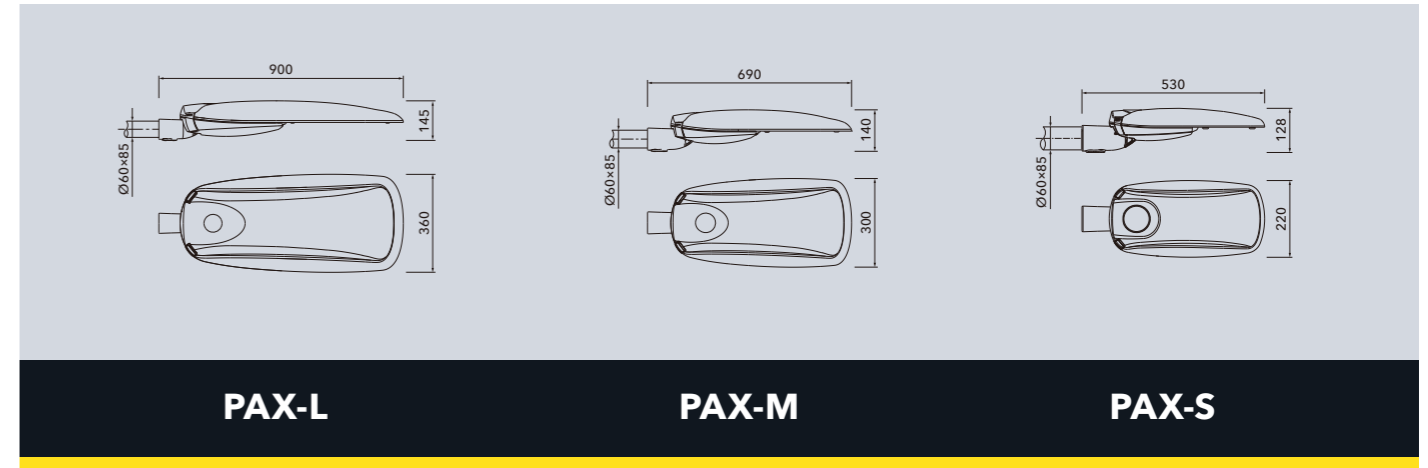

Unique body design with a concave structure to create an 'air duct' effect for improved heat dissipation.

Accessories

- Ø76mm Fixing Arm
- Ø60-42mm Adapter

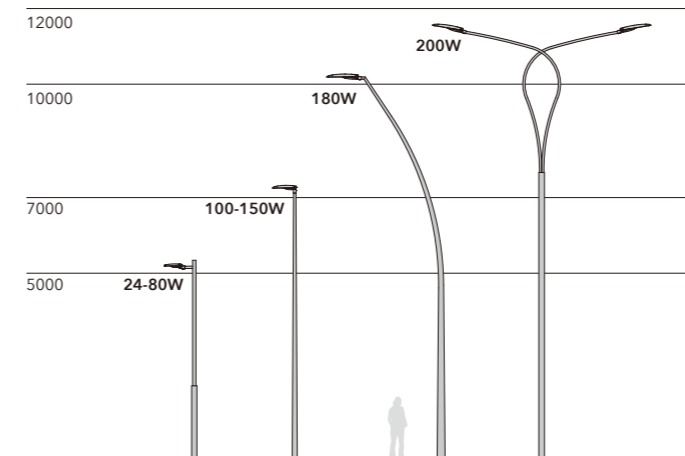

# PEDESTRIAN LIGHT

A range of pole mounted luminaires suitable for a variety of exterior applications such as pedestrian areas, parks, footpaths and contemporary architectural spaces.



**CIRTA**  
P38

Power	24-80W
CCT	3000/4000
Lumen Output	2860-11400



**SORA**  
P42

**LULA**  
P46

Power	40-60W	40-100W
CCT	3000/4000	3000/4000
Lumen Output	4710-9100	4780-14030



**ELENIO**  
P48

**VASA**  
P50

**URCI**  
P52

Power	40-60W	24-80W	60-120W
CCT	4000	3000/4000	3000/4000
Lumen Output	5300-7800	3120-10070	8400-16790



**GALLIA**  
P54

**SCOTIA**  
P56

**POLA**  
P58

**DANIA**  
P60

Power	40-120W	60W	50-60W	30-60W
CCT	3000	3000/4000	4000	3000/4000
Lumen Output	2800-8400	6310/6600	4680-6870	2700-6300



A modern take on a classic design, the CIRTA range of pole mounted luminaires has a variety of styles to suit different applications. With options from 24W to 80W, it is ideal for use in pedestrian areas, parks and general open spaces.

- Die-cast aluminium housing with super white tempered glass and polycarbonate reflector.
- Optical lenses with multiple distribution options, offering visual comfort and uniform light distribution.
- High quality LED chips and DALI driver as standard, with in-built surge protection up to 20KV.
- A variety of styles to suit different requirements and applications.
- Suitable for pole mounting on Ø60mm poles.
- UV protected pure polyester powder coated housing offering high corrosion resistance.
- Suitable for use with a range of controls and remote management systems.
- All external screws are 304 stainless steel as standard.
- RAL9005, other RAL colours available on request.

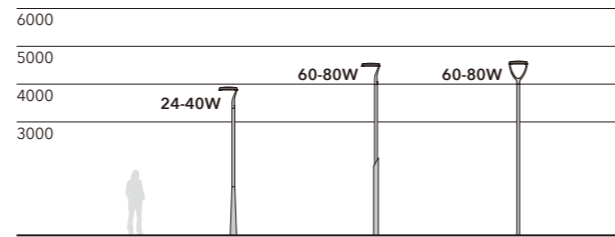

CODE	POWER	LED PCS	CCT	LUMEN OUTPUT	CRI	BEAM ANGLE	IP	IK	WARRANTY
CIR-V-24-T1	24W	16	3000/4000	2900/3120	>70	T1	IP66	IK08	5 year
CIR-V-24-T2W				2910/3080		T2W			
CIR-V-40-T1	40W	24	3000/4000	5280/5640	>70	T1	IP66	IK08	5 year
CIR-V-40-T2W				5220/5580		T2W			
CIR-V-60-T1	60W	24	3000/4000	7800/8410	>70	T1	IP66	IK08	5 year
CIR-V-60-T2W				7800/8290		T2W			
CIR-V-80-T1D	80W	36	3000/4000	10600/11400	>70	T1D	IP66	IK08	5 year
CIR-V-80-T2D				10410/11220		T2D			
CIR-R-24-T1	24W	16	3000/4000	2920/3150	>70	T1	IP66	IK08	5 year
CIR-R-24-T2W				2860/3080		T2W			
CIR-R-40-T1	40W	24	3000/4000	5380/5690	>70	T1	IP66	IK08	5 year
CIR-R-40-T2W				5260/5640		T2W			
CIR-R-60-T1	60W	24	3000/4000	7900/8510	>70	T1	IP66	IK08	5 year
CIR-R-60-T2W				7830/8410		T2W			
CIR-R-80-T1D	80W	36	3000/4000	10440/11150	>70	T1D	IP66	IK08	5 year
CIR-R-80-T2D				10360/11120		T2D			



**CIR-R-24**

**CIR-V-24**

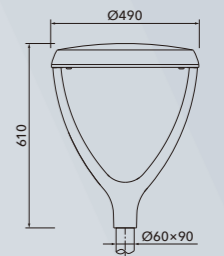

CIR-V

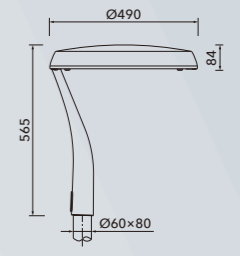

CIR-R

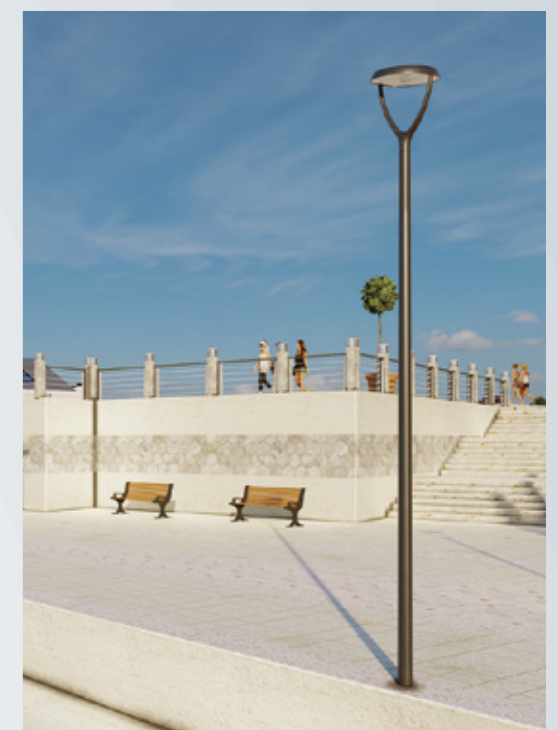

A modern take on a classic design, the CIRTA range of pole mounted luminaires has a variety of styles to suit different applications. With options from 24W to 80W, it is ideal for use in pedestrian areas, parks and general open spaces.

- Die-cast aluminium housing with super white tempered glass and polycarbonate reflector.
- Optical lenses with multiple distribution options, offering visual comfort and uniform light distribution.
- High quality LED chips and DALI driver as standard, with in-built surge protection up to 20KV.
- A variety of styles to suit different requirements and applications.
- Suitable for pole mounting on Ø60mm poles.
- UV protected pure polyester powder coated housing offering high corrosion resistance.
- Suitable for use with a range of controls and remote management systems.
- All external screws are 304 stainless steel as standard.
- RAL9005, other RAL colours available on request.

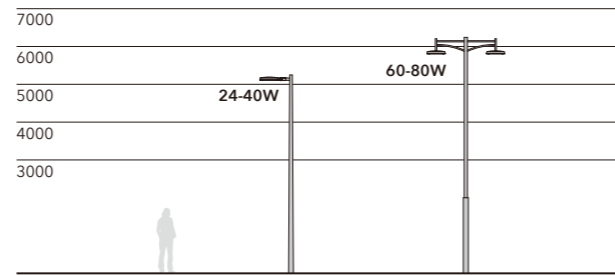

CODE	POWER	LED PCS	CCT	LUMEN OUTPUT	CRI	BEAM ANGLE	IP	IK	WARRANTY
CIR-T-24-T1	24W	16	3000/4000	2910/3130	>70	T1	IP66	IK08	5 year
CIR-T-24-T2W				2880/3090		T2W			
CIR-T-40-T1	40W	24	3000/4000	5310/5640	>70	T1	IP66	IK08	5 year
CIR-T-40-T2W				5270/5660		T2W			
CIR-T-60-T1	60W	24	3000/4000	7830/8410	>70	T1	IP66	IK08	5 year
CIR-T-60-T2W				7930/8510		T2W			
CIR-T-80-T1D	80W	36	3000/4000	10540/11250	>70	T1D	IP66	IK08	5 year
CIR-T-80-T2D				10460/11220		T2D			
CIR-S-24-T1	24W	16	3000/4000	2910/3130	>70	T1	IP66	IK08	5 year
CIR-S-24-T2W				2880/3100		T2W			
CIR-S-40-T1	40W	24	3000/4000	5310/5640	>70	T1	IP66	IK08	5 year
CIR-S-40-T2W				5270/5670		T2W			
CIR-S-60-T1	60W	24	3000/4000	7830/8410	>70	T1	IP66	IK08	5 year
CIR-S-60-T2W				7940/8520		T2W			
CIR-S-80-T1D	80W	36	3000/4000	10550/11250	>70	T1D	IP66	IK08	5 year
CIR-S-80-T2D				10470/11230		T2D			



**CIR-T-24**



**CIR-S-24**

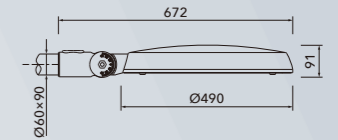

CIR-T

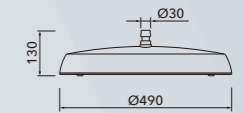

CIR-S



A modern and efficient post top luminaire that is ideal for pedestrian areas, courtyards and pathways and available in two outputs. An optional diffuser accessory is also available.

- Die-cast aluminium housing with super white tempered glass and polycarbonate reflector.
- Optical lens offering visual comfort and uniform light distribution.
- High quality LED chips and DALI driver as standard, with in-built surge protection up to 20KV.
- Suitable for pole mounting on Ø60mm poles.
- UV protected pure polyester powder coated housing offering high corrosion resistance.
- Suitable for use with a range of controls and remote management systems.
- All external screws are 304 stainless steel as standard.
- RAL9007, other RAL colours available on request.

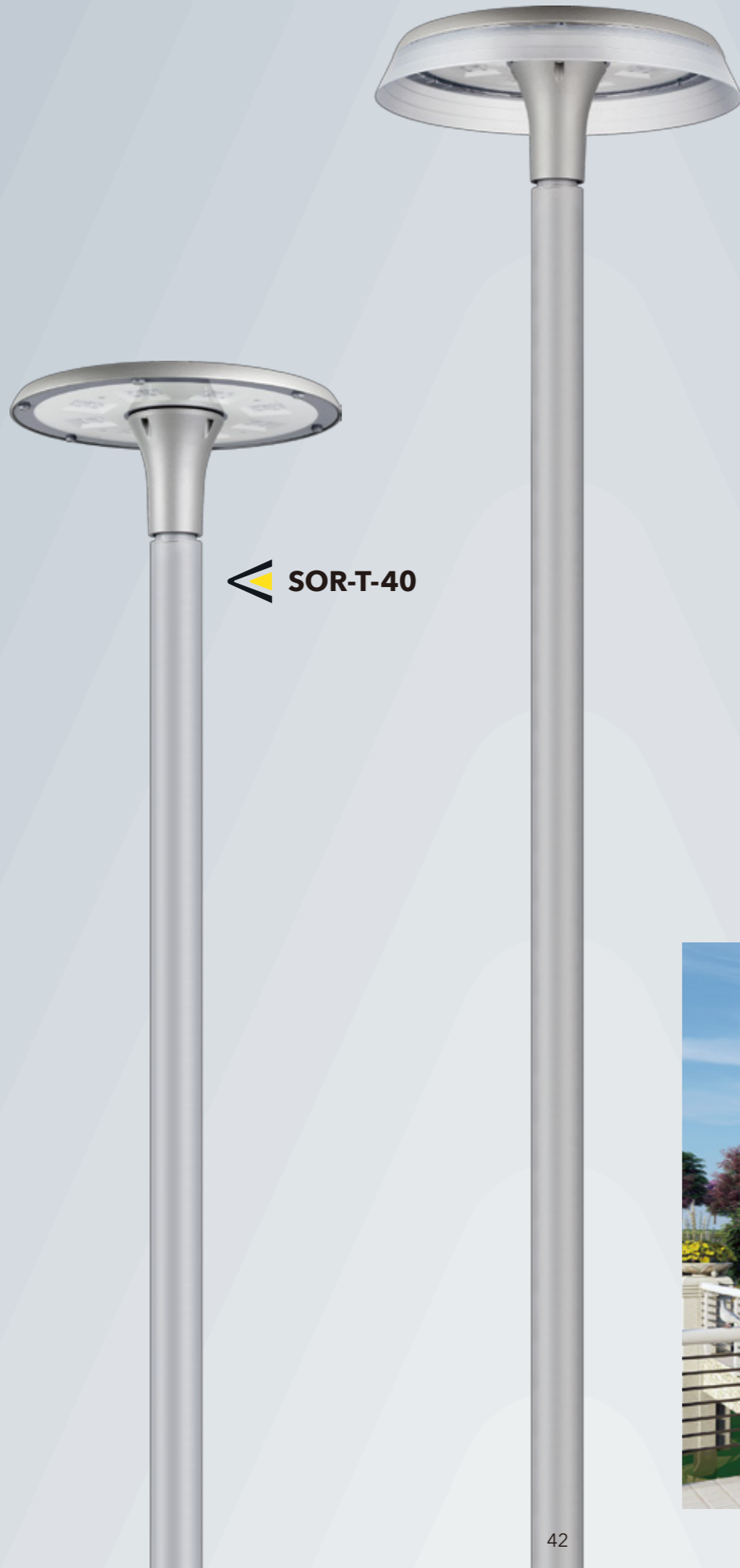

**SOR-T-DIF**

**SOR-T-40**

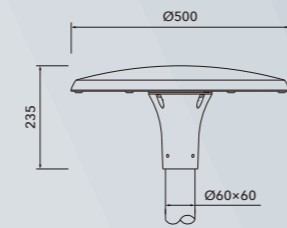

SOR-T

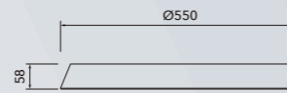

SOR-T-DIF



**Accessories**

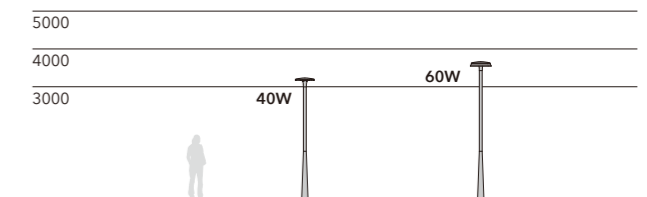

CODE	POWER	LED PCS	CCT	LUMEN OUTPUT	CRI	BEAM ANGLE	IP	IK	WARRANTY
SOR-T-40-T1	40W	32	4000	6270	>70	T1	IP66	IK08	5 year
SOR-T-60-T1	60W	32	4000	9100	>70	T1	IP66	IK08	5 year
SOR-T-DIF	--	--	--	--	--	--	--	--	--



**SOR-C-40**



**SOR-V-40**

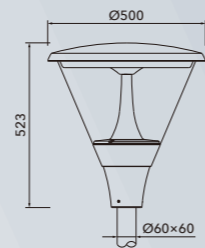

SOR-C

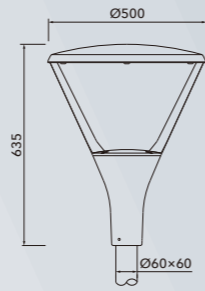

SOR-V



A modern take on a classic design with two styles to suit different applications. With two outputs available in each style and direct and indirect lighting options it is ideal for use in pedestrian areas, parks and general open spaces.

- Die-cast aluminium housing with super white tempered glass and polycarbonate reflector.
- Optical lens offering visual comfort and uniform light with different distribution options.
- High quality LED chips and DALI driver as standard, with in-built surge protection up to 20KV.
- Suitable for pole mounting on Ø60mm poles.
- Direct and indirect lighting options for different applications.
- UV protected pure polyester powder coated housing offering high corrosion resistance.
- Suitable for use with a range of controls and remote management systems.
- All external screws are 304 stainless steel as standard.
- RAL9007, other RAL colours available on request.

**Accessories**

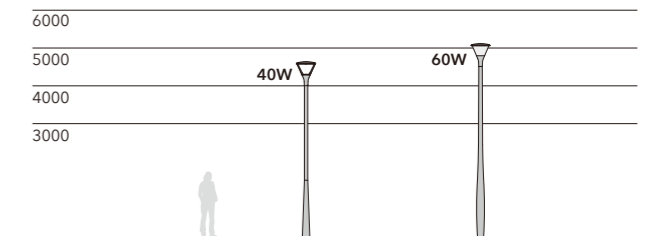
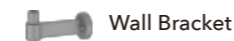

CODE	POWER	LED PCS	CCT	LUMEN OUTPUT	CRI	BEAM ANGLE	IP	IK	WARRANTY
SOR-C-40-T32B	40W	128	4000	5260	>70	T32B	IP66	IK08	5 year
SOR-C-60-T32B	60W	128	4000	7570	>70	T32B	IP66	IK08	5 year
SOR-V-40-T1	40W	16	3000/4000	4980/5380	>70	T1	IP66	IK08	5 year
SOR-V-40-T2W	40W	16	3000/4000	4710/5110	>70	T2W	IP66	IK08	5 year
SOR-V-60-T1	60W	32	3000/4000	7550/8130	>70	T1	IP66	IK08	5 year
SOR-V-60-T2W	60W	32	3000/4000	7210/7730	>70	T2W	IP66	IK08	5 year

A classic post top luminaire available in two styles to offer flexibility across a variety of applications. An ideal solution for pathways, pedestrian areas, courtyards and small car parks.

- Die-cast aluminium housing with super white tempered glass and chrome plastic reflector.
- Optical lens offering visual comfort and uniform light distribution.
- High quality LED chips and driver, with in-built surge protection up to 20KV.
- Button release mechanism for ease of installation and maintenance.
- Suitable for pole mounting on Ø60mm poles.
- UV protected pure polyester powder coated housing offering high corrosion resistance.
- Suitable for use with a range of controls and remote management systems.
- All external screws are 304 stainless steel as standard.
- RAL9005, other RAL colours available on request.

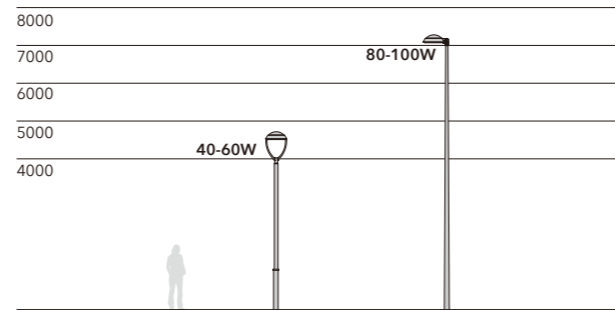

CODE	POWER	LED PCS	CCT	LUMEN OUTPUT	CRI	BEAM ANGLE	IP	IK	WARRANTY
LUL-T-40-T4A	40W	16	3000/4000	5230/5600	>70	T4A	IP66	IK08	5 year
LUL-T-60-T4D	60W	24	3000/4000	7830/8450	>70	T4D	IP66	IK08	5 year
LUL-T-80-T4A	80W	32	3000/4000	10400/11210	>70	T4A	IP66	IK08	5 year
LUL-T-100-T4D	100W	48	3000/4000	13200/14030	>70	T4D	IP66	IK08	5 year
LUL-V-40-T2W	40W	16	3000/4000	4780/5200	>70	T2W	IP66	IK08	5 year
LUL-V-40-T4A	40W	16	3000/4000	4840/5260	>70	T4A	IP66	IK08	5 year
LUL-V-60-T4D	60W	24	3000/4000	7270/7890	>70	T4D	IP66	IK08	5 year
LUL-V-80-T4A	80W	32	3000/4000	9690/10620	>70	T4A	IP66	IK08	5 year
LUL-V-100-T4D	100W	48	3000/4000	12100/13200	>70	T4D	IP66	IK08	5 year



**LUL-T-40**



**LUL-V-40**

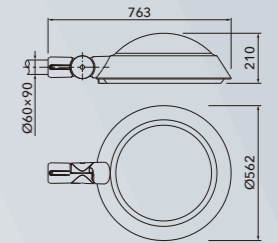

LUL-T

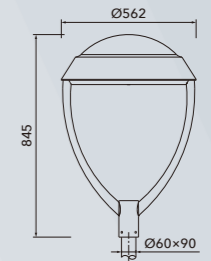

LUL-V





A classic post top luminaire available in two styles to offer flexibility across a variety of applications. An ideal solution for pathways, pedestrian areas, courtyards and small car parks.

- Die-cast aluminium housing with transparent and prismatic diffuser options.
- Optical lens offering visual comfort and uniform light distribution.
- High quality LED chips and driver, with in-built surge protection up to 20KV.
- Suitable for pole mounting on Ø60mm & Ø76mm poles.
- UV protected pure polyester powder coated housing offering high corrosion resistance.
- Suitable for use with a range of controls and remote management systems.
- All external screws are 304 stainless steel as standard.
- RAL9005, other RAL colours available on request.

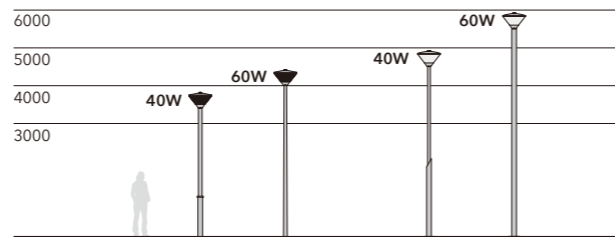

CODE	POWER	LED PCS	CCT	LUMEN OUTPUT	CRI	BEAM ANGLE	IP	IK	WARRANTY
ELE-C-40-T32B	40W	128	4000	5400	>70	T32B	IP65	IK09	5 year
ELE-C-60-T32B	60W	128	4000	7800	>70	T32B	IP65	IK09	5 year
ELE-P-40-T1	40W	24	4000	5300	>70	T1	IP65	IK09	5 year
ELE-P-60-T1	60W	24	4000	7800	>70	T1	IP65	IK09	5 year



**ELE-C-T32B**



**ELE-P-T1**

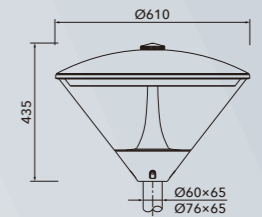

ELE-C

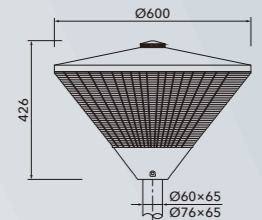

ELE-P



Contemporary and stylish luminaire available in a range of outputs. Ideal for pedestrian areas, terraces and general open spaces.

- Die-cast aluminium housing with super white tempered glass and polycarbonate reflector.
- Optical lens offering visual comfort and uniform light distribution.
- High quality LED chips and DALI driver as standard, with in-built surge protection up to 20KV.
- Suitable for pole mounting on Ø60mm poles.
- UV protected pure polyester powder coated housing offering high corrosion resistance.
- Suitable for use with a range of controls and remote management systems.
- All external screws are 304 stainless steel as standard.
- RAL9005, other RAL colours available on request.

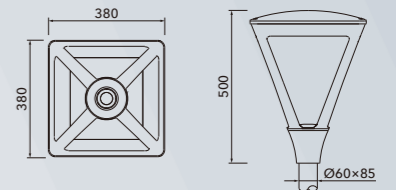
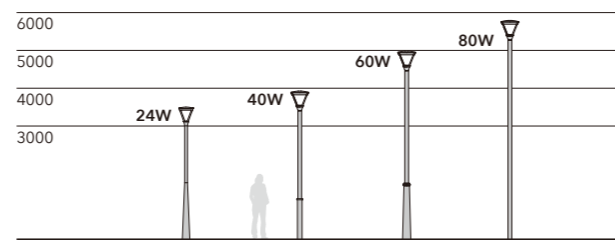

VAS



CODE	POWER	LED PCS	CCT	LUMEN OUTPUT	CRI	BEAM ANGLE	IP	IK	WARRANTY
VAS-S24-T1	24W	16	3000/4000	3150/3320	>70	T1	IP66	IK09	5 year
VAS-S24-T2W				3120/3260		T2W			
VAS-S40-T1	40W	24	3000/4000	5240/5410	>70	T1	IP66	IK09	5 year
VAS-S40-T2W				5160/5320		T2W			
VAS-S60-T1	60W	24	3000/4000	6100/6550	>70	T1	IP66	IK09	5 year
VAS-S60-T2W				5980/6300		T2W			
VAS-S80-T1D	80W	36	3000/4000	9660/10070	>70	T1D	IP66	IK09	5 year
VAS-S80-T2D				9340/9840		T2D			



A modern and minimalistic style luminaire available with four outputs, ideal for walkways and pedestrian areas. A round pole fixing bracket and wall mounting bracket are also available.

- Die-cast aluminium housing with polycarbonate diffuser and chrome reflector.
- Optical lens offering visual comfort and uniform light distribution with different distribution options.
- High quality LED chips and driver.
- UV protected pure polyester powder coated housing offering high corrosion resistance.
- Suitable for use with a range of controls and remote management systems.
- All external screws are 304 stainless steel as standard.
- RAL9005, other RAL colours available on request.

**Accessories**

-  Square Poles
-  Round Pole Mounting Bracket
-  Wall Mounted Flange

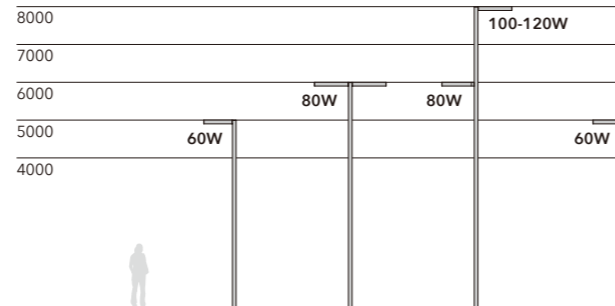

CODE	POWER	LED PCS	CCT	LUMEN OUTPUT	CRI	BEAM ANGLE	IP	IK	WARRANTY
URC-S60-T1				8790/9410		T1			
URC-S60-T2W	60W	32	3000/4000	8700/9300	>70	T2W	IP66	IK08	5 year
URC-S60-T3A				8400/9000		T3A			
URC-M80-T1	80W	32	3000/4000	11400/12190	>70	T1	IP66	IK08	5 year
URC-M80-T3A				10760/11540		T3A			
URC-M100-T1	100W	32	3000/4000	13460/14450	>70	T1	IP66	IK08	5 year
URC-M100-T3A				13050/14010		T3A			
URC-M120-T1	120W	32	3000/4000	15790/16790	>70	T1	IP66	IK08	5 year
URC-M120-T3A				15060/16060		T3A			

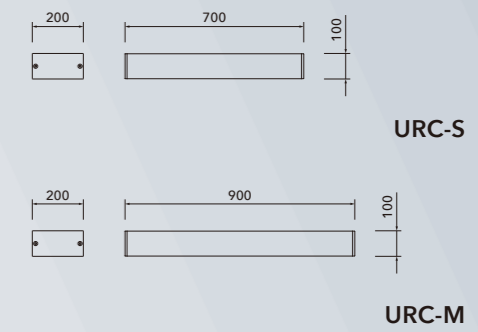
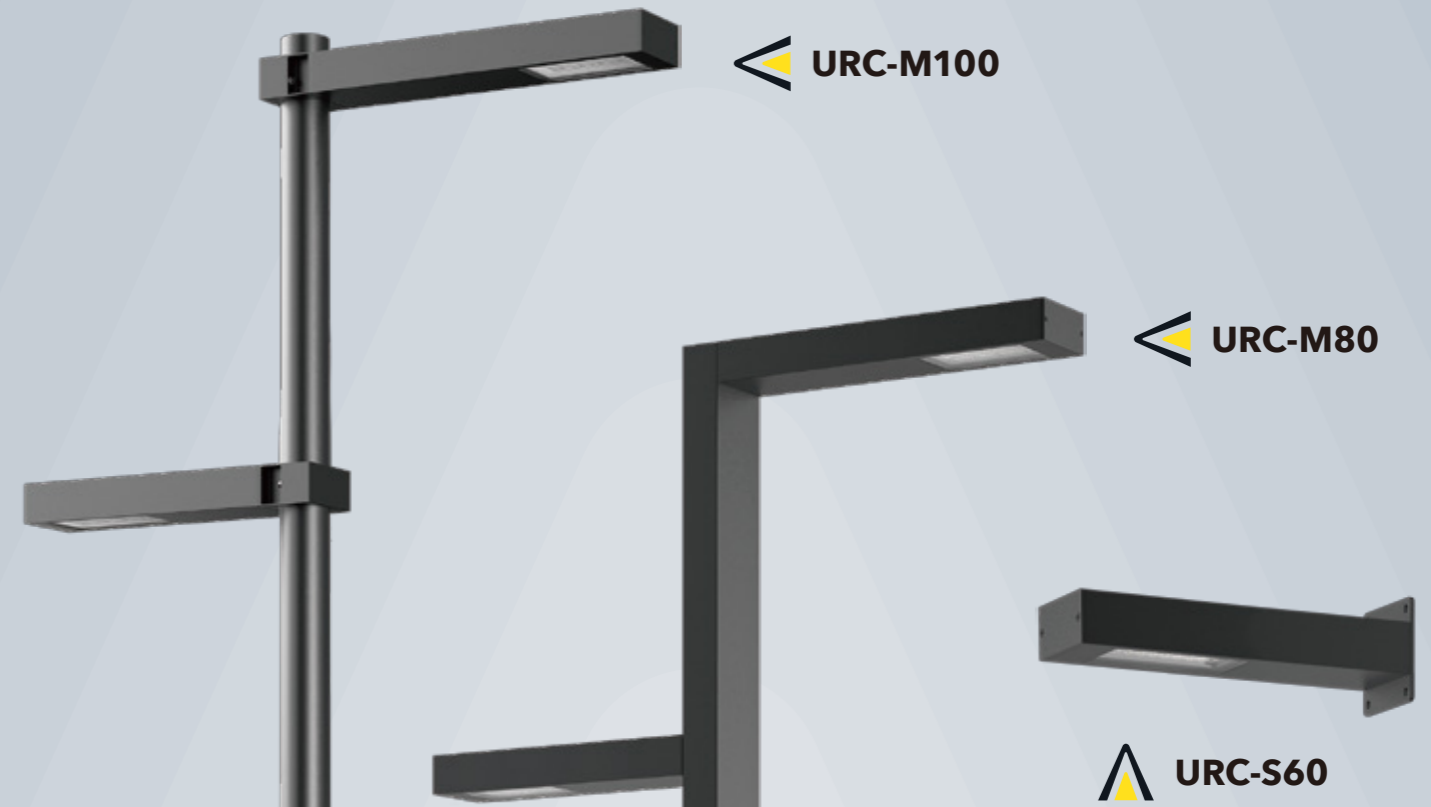

**GAL-H450-120**

**GAL-H350-80**

**GAL-H250-40**

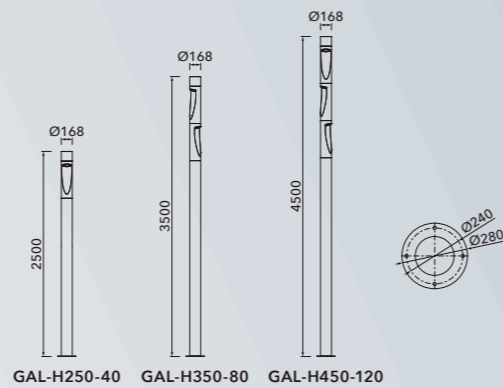

GAL



A range of 2.5m to 4.5m tall luminaires with single, double and triple rotatable light sources to ensure the light is distributed downwards and exactly where required. A matching bollard is also available.

- Extruded aluminium pole with die-cast lamp head and tempered glass lens.
- Rotatable lamp heads allow effective and accurate direction of light.
- High quality LED chips and driver with easy mechanisms for replacement.
- UV protected pure polyester powder coated housing offering high corrosion resistance.
- Suitable for use with a range of controls and remote management systems.
- All external screws are 304 stainless steel as standard.
- RAL9007, other RAL colours available on request.
- Other sizes available on request.



**GALLIA Range**

Page 116

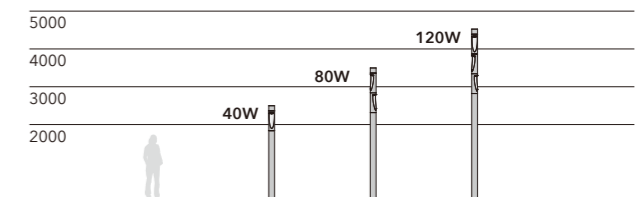

CODE	POWER	LED PCS	CCT	LUMEN OUTPUT	CRI	BEAM ANGLE	IP	IK	WARRANTY
GAL-H250-40-TM3A	40W	18	3000	2800	>70	TM3A18	IP66	IK08	5 year
GAL-H350-80-TM3A	80W	36	3000	5600	>70	TM3A18	IP66	IK08	5 year
GAL-H450-120-TM3A	120W	54	3000	8400	>70	TM3A18	IP66	IK08	5 year

A tall, square pedestrian light ideal for pedestrian and open areas such as shopping centres and courtyards. Available in 4m and 5m heights.

- Extruded aluminium pole with die-cast lamp head and polycarbonate diffuser.
- Symmetric light distribution with high quality visual effect.
- High quality LED chips and driver.
- UV protected pure polyester powder coated housing offering high corrosion resistance.
- Suitable for use with a range of controls and remote management systems.
- All external screws are 304 stainless steel as standard.
- RAL9005, other RAL colours available on request.

◀ **SCO-H400-60**

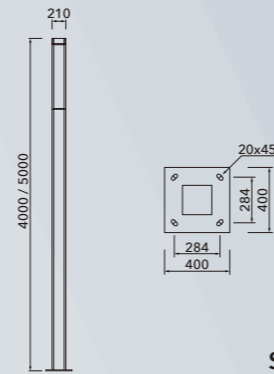

SCO

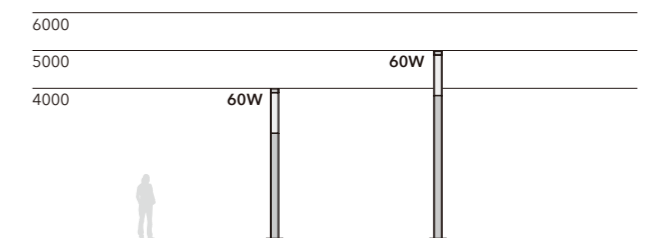

CODE	POWER	LED PCS	CCT	LUMEN OUTPUT	CRI	BEAM ANGLE	IP	IK	WARRANTY
SCO-H400-60-90	60W	24	3000/4000	6310/6600	>70	90°	IP66	IK08	5 year
SCO-H500-60-90	60W	24	3000/4000	6310/6600	>70	90°	IP66	IK08	5 year

A stylish and modern column luminaire available with a clear diffuser or with integrated louvre for low glare. Two heights are available in each style.

- Extruded aluminium pole with die-cast lamp head and polycarbonate diffuser.
- Two versions available with different light distribution: top light source with clear diffuser and central light source with anti-glare louvre.
- High quality LED chips and driver.
- UV protected pure polyester powder coated housing offering high corrosion resistance.
- Suitable for use with a range of controls and remote management systems.
- All external screws are 304 stainless steel as standard.
- RAL9007, other RAL colours available on request.
- Other sizes available on request.

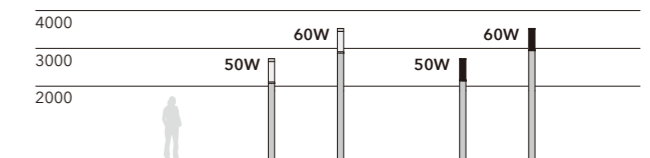
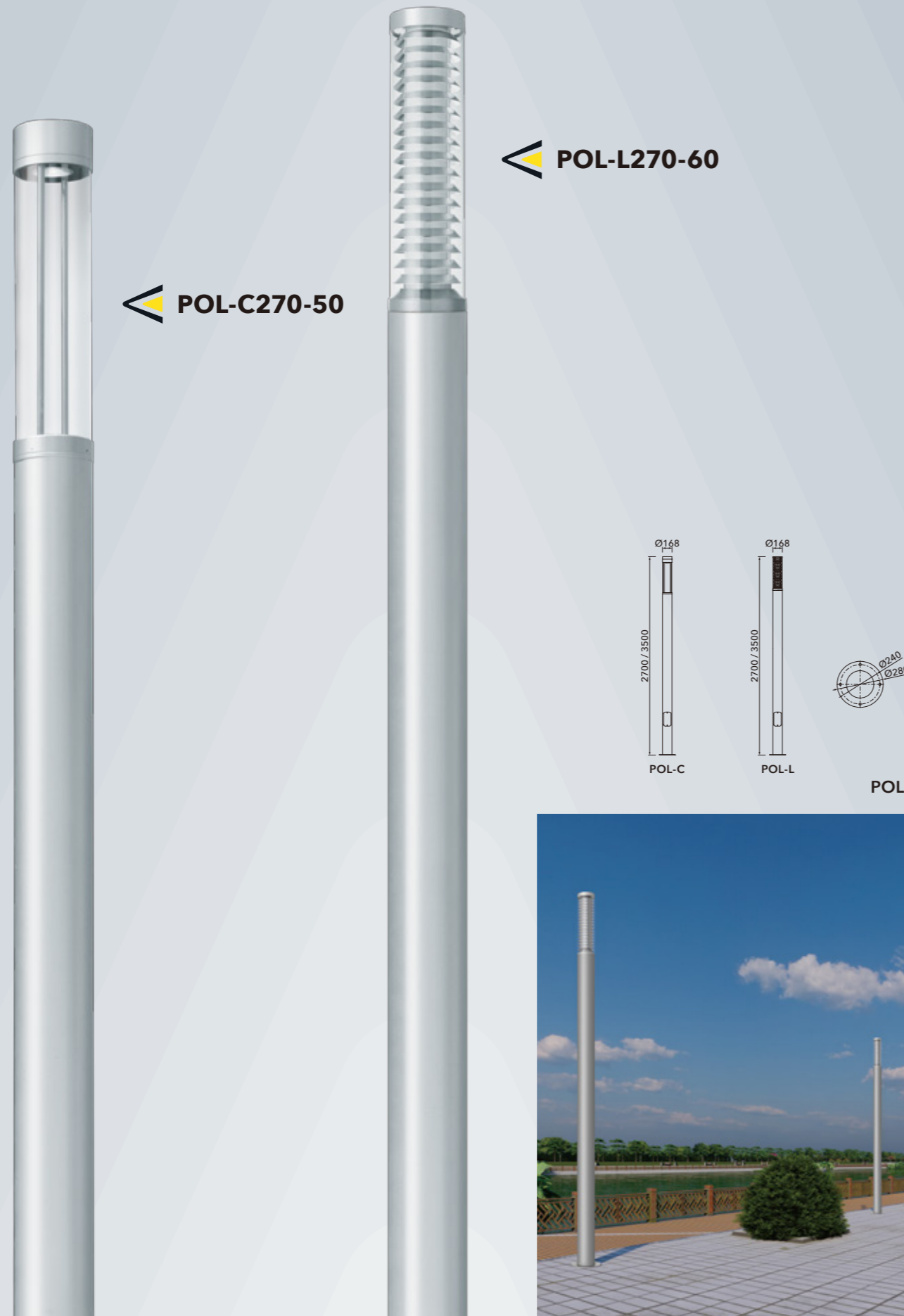

CODE	POWER	LED PCS	CCT	LUMEN OUTPUT	CRI	BEAM ANGLE	IP	IK	WARRANTY
POL-C270-50-TM1	50W	18	4000	6870	>70	TM1T18	IP66	IK09	5 year
POL-C350-50-TM1	50W	18	4000	6870	>70	TM1T18	IP66	IK09	5 year
POL-L270-60-120	60W	576	4000	4680	>70	120°	IP66	IK09	5 year
POL-L350-60-120	60W	576	4000	4680	>70	120°	IP66	IK09	5 year

A modern and stylish take on a pedestrian style luminaire which is available in three outputs. Ideal for use in open areas, parks, courtyards and walkways.

- Die-cast aluminium housing with super white tempered glass and polycarbonate reflector.
- Three outputs with a high quality lens to ensure a comfortable lighting effect and good light distribution.
- High quality LED chips and driver, with in-built surge protection up to 10KV.
- Suitable for pole mounting on Ø60mm & Ø76mm poles.
- UV protected pure polyester powder coated housing offering high corrosion resistance.
- Suitable for use with a range of controls and remote management systems.
- All external screws are 304 stainless steel as standard.
- RAL9007, other RAL colours available on request.

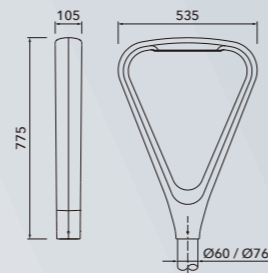

DAN



**DAN-30**

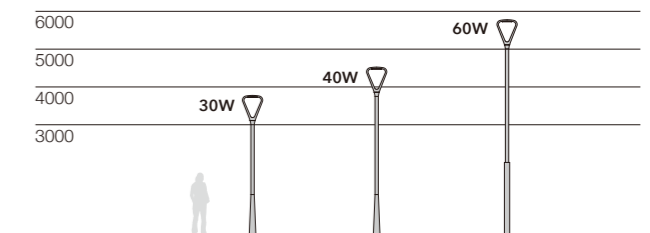

CODE	POWER	LED PCS	CCT	LUMEN OUTPUT	CRI	BEAM ANGLE	IP	IK	WARRANTY
DAN-30-T4A	30W	12	3000/4000	2700/3000	>70	T4A	IP66	IK08	5 year
DAN-40-T1D	40W	18	3000/4000	4080/4400	>70	T1D	IP66	IK08	5 year
DAN-60-T1D	60W	18	3000/4000	5770/6300	>70	T1D	IP66	IK08	5 year

# MAST LIGHTING

A mast luminaire designed for very high installation to provide effective lighting in large open areas. Ideal for large car parks, airports and other open spaces.



## SAVO

P64

Power	480-720W
CCT	3000/4000
Lumen Output	63690-99360





A mast luminaire designed for high pole applications. Using the latest high efficiency LED technology, it offers a complete lighting solution for the simplest to most complex lighting applications. Specialist lenses ensure high performance and optimum light distribution.

- Die-cast aluminium construction with separate lamp head and control gear housing.
- Optical lenses offering visual comfort and uniform light distribution.
- High quality LED chips and DALI driver as standard, with in-built surge protection up to 20KV.
- Tool-free, easy open housing for fast installation and maintenance. Rated to IP66 with plug connector for easy disconnection from the mains supply.
- Suitable for side pole mounting on Ø42mm-Ø60mm poles.
- UV protected pure polyester powder coated housing offering high corrosion resistance.
- Suitable for use with a range of controls and remote management systems.
- All external screws are 304 stainless steel as standard.
- RAL9007, other RAL colours available on request.



CODE	POWER	LED PCS	CCT	LUMEN OUTPUT	CRI	BEAM ANGLE	IP	IK	WARRANTY
SAV-480-T6A	480W	144	3000/4000	63690/68440	>70	T6A	IP66	IK09	5 year
SAV-600-TM6A	600W	216	3000/4000	80520/87100	>70	TM6A	IP66	IK09	5 year
SAV-660-TM6A	660W	216	3000/4000	86390/92730	>70	TM6A	IP66	IK09	5 year
SAV-720-TM6A	720W	216	3000/4000	92370/99360	>70	TM6A	IP66	IK09	5 year



 **SAV-480**





Independent IP66 control gear housing with plug in electrical connection for easy maintenance.

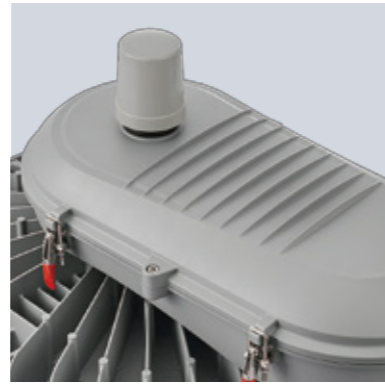

Unique housing design with integrated heat dissipation and flexibility to add intelligent lighting controls.

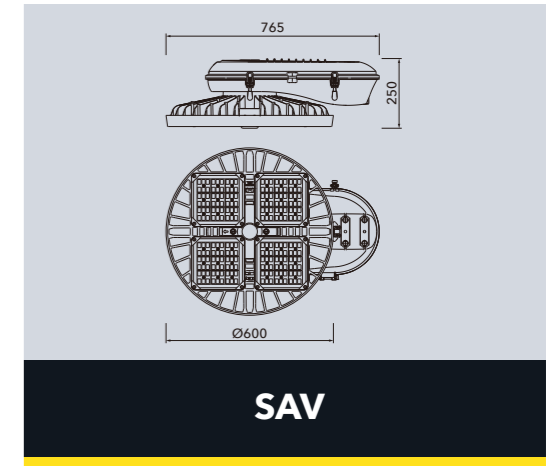

SAV



Specialist four bolt pole mounting mechanism allows fixing to Ø42mm to Ø60mm poles with a 5° adjustable angle.



IK09 heavy duty tempered glass lens for durability and high quality lenses.



LED lamp head can be rotated 180° to allow optimum light distribution.

# TRADITIONAL

A range of heritage lighting perfect for the areas that want to maintain traditional styling whilst utilising modern technology.



**LONDINIUM**  
P70



**GOTHIA**  
P72



**OXONIA**  
P74

Power	24-80W	24-80W	24-80W
CCT	3000/4000	3000/4000	3000/4000
Lumen Output	2760-10410	2790-9870	2880-10560



**MONA**  
P76



**CALEDONIA**  
P78

Power	40-60W	60-180W
CCT	4000	3000/4000
Lumen Output	5640-8410	8100-25830





◀ **LON-24**

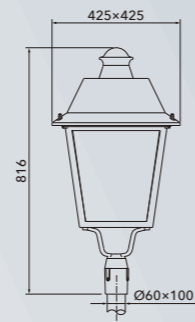

LON



An updated version of the classic and timeless lantern for column mounting, available in multiple outputs. A wall mounting bracket is also available as an accessory.

- Die-cast aluminium housing with super white tempered glass and chrome reflector.
- Optical lenses offering visual comfort and uniform light distribution.
- High quality LED chips and DALI driver as standard, with in-built surge protection up to 20KV.
- Classic design with optional wall mounting bracket accessory.
- UV protected pure polyester powder coated housing offering high corrosion resistance.
- Suitable for use with a range of controls and remote management systems.
- All external screws are 304 stainless steel as standard.
- RAL9005, other RAL colours available on request.

**Accessories**



Wall Mounted Bracket

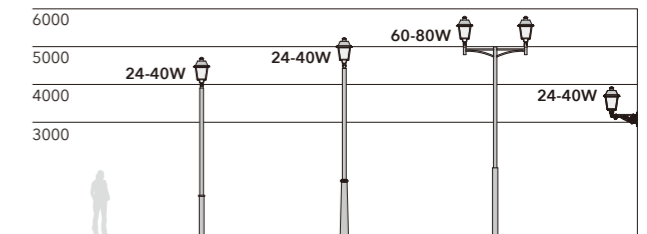

CODE	POWER	LED PCS	CCT	LUMEN OUTPUT	CRI	BEAM ANGLE	IP	IK	WARRANTY
LON-24-T1	24W	12	3000/4000	2880/3120	>70	T1	IP66	IK09	5 year
LON-24-T2W				2760/3000		T2W			
LON-40-T1	40W	24	3000/4000	4810/5260	>70	T1	IP66	IK09	5 year
LON-40-T2W				4600/5000		T2W			
LON-60-T1	60W	24	3000/4000	7200/7800	>70	T1	IP66	IK09	5 year
LON-60-T2W				6900/7500		T2W			
LON-80-T1D	80W	36	3000/4000	9620/10410	>70	T1D	IP66	IK09	5 year



**GOT-24**

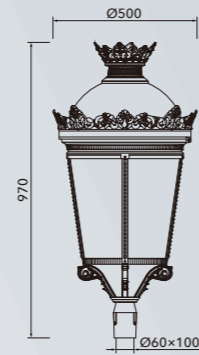

**GOT**



Inspired by the lanterns first seen in royal parks during the Regency era, the Gothia range is both decorative and discreet. A wall mounting bracket and diamond frosted diffuser are available as accessories.

- Die-cast aluminium housing with high quality tempered glass and chrome reflector.
- Optical lenses offering visual comfort and uniform light distribution.
- High quality LED chips and DALI driver as standard, with in-built surge protection up to 20KV.
- Classic design with optional wall mounting bracket and diamond diffuser available as accessories.
- UV protected pure polyester powder coated housing offering high corrosion resistance.
- Suitable for use with a range of controls and remote management systems.
- All external screws are 304 stainless steel as standard.
- RAL9005, other RAL colours available on request.

**Accessories**



Wall Mounted Bracket



Diamond Diffuser

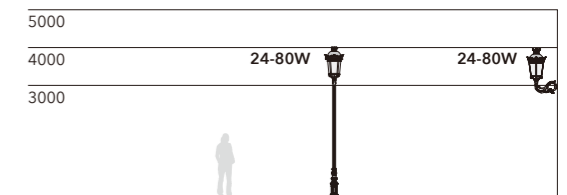

CODE	POWER	LED PCS	CCT	LUMEN OUTPUT	CRI	BEAM ANGLE	IP	IK	WARRANTY
GOT-24-T1	24W	12	3000	2790	>70	T1	IP66	IK09	5 year
GOT-40-T1	40W	24	3000/4000	4610/4840	>70	T1	IP66	IK09	5 year
GOT-60-T1	60W	24	3000/4000	7000/7350	>70	T1	IP66	IK09	5 year
GOT-80-T1D	80W	36	3000/4000	9400/9870	>70	T1D	IP66	IK09	5 year

A modern design of a classic luminaire borrowing inspiration from European styling and available in four outputs.

- Die-cast aluminium housing with polycarbonate diffuser and chrome reflector.
- Optical lenses offering visual comfort and uniform light distribution.
- High quality LED chips and DALI driver as standard, with in built surge protection up to 20KV.
- UV protected pure polyester powder coated housing offering high corrosion resistance.
- Suitable for use with a range of controls and remote management systems.
- All external screws are 304 stainless steel as standard.
- RAL9005, other RAL colours available on request.

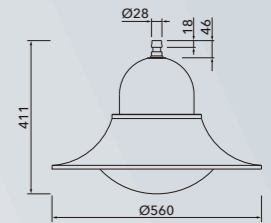
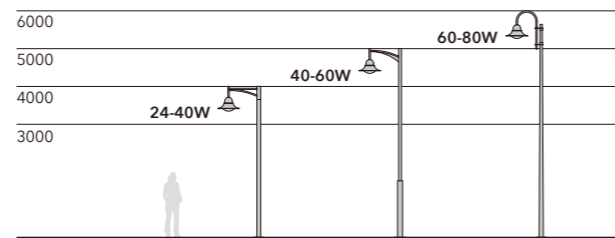

**OXO-24**

OXO



CODE	POWER	LED PCS	CCT	LUMEN OUTPUT	CRI	BEAM ANGLE	IP	IK	WARRANTY
OXO-24-T1	24W	12	3000/4000	3040/3270	>70	T1	IP66	IK09	5 year
OXO-24-T2W				2880/3120		T2W			
OXO-40-T1	40W	24	3000/4000	5050/5440	>70	T1	IP66	IK09	5 year
OXO-40-T2W				4800/5200		T2W			
OXO-60-T1	60W	24	3000/4000	7510/8110	>70	T1	IP66	IK09	5 year
OXO-60-T2W				7200/7800		T2W			
OXO-80-T1D	80W	36	3000/4000	10100/10560	>70	T1D	IP66	IK09	5 year

A classic spherical luminaire with two outputs, ideal for pedestrian areas, parks and walkways.

- Galvanised steel housing with high quality tempered glass and chrome reflector.
- Optical lenses offering visual comfort and uniform light distribution.
- High quality LED chips and DALI driver as standard, with in-built surge protection up to 20KV.
- UV protected pure polyester powder coated housing offering high corrosion resistance.
- Suitable for use with a range of controls and remote management systems.
- All external screws are 304 stainless steel as standard.
- RAL9005, other RAL colours available on request.

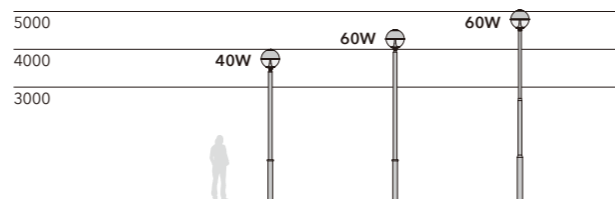

CODE	POWER	LED PCS	CCT	LUMEN OUTPUT	CRI	BEAM ANGLE	IP	IK	WARRANTY
MON-40-T32B	40W	128	4000	5640	>70	T32B	IP65	IK09	5 year
MON-60-T32B	60W	128	4000	8410	>70	T32B	IP65	IK09	5 year



**MON-40**

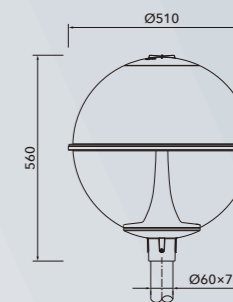

MON



A classic crown luminaire inspired by traditional railway gas lanterns. Supplied with an elegant bracket for pole mounting and in a range of outputs.

- Die-cast aluminium housing with polycarbonate diffuser.
- Optical lenses offering visual comfort and uniform light distribution.
- High quality LED chips and driver with in built surge protection up to 20KV.
- Classic design supplied with pole mounting bracket.
- UV protected pure polyester powder coated housing offering high corrosion resistance.
- Suitable for use with a range of controls and remote management systems.
- All external screws are 304 stainless steel as standard.
- RAL9005, other RAL colours available on request.

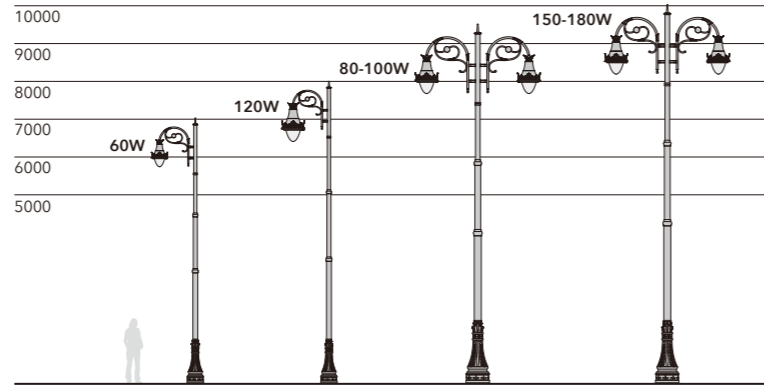

CODE	POWER	LED PCS	CCT	LUMEN OUTPUT	CRI	BEAM ANGLE	IP	IK	WARRANTY
CAL-S60-T1	60W	36	3000/4000	8310/8910	>70	T1	IP66	IK08	5 year
CAL-S60-T3A				8100/8700		T3A			
CAL-S80-T1	80W	36	3000/4000	10960/11850	>70	T1	IP66	IK08	5 year
CAL-S80-T3A				10800/11600		T3A			
CAL-S100-T1	100W	36	3000/4000	13650/14650	>70	T1	IP66	IK08	5 year
CAL-S100-T3A				13500/14500		T3A			
CAL-M120-T1	120W	48	3000/4000	16270/17350	>70	T1	IP66	IK08	5 year
CAL-M120-T3A				15600/16800		T3A			
CAL-M150-T1	150W	48	3000/4000	20190/21640	>70	T1	IP66	IK08	5 year
CAL-M150-T3A				19500/21000		T3A			
CAL-M180-T1	180W	64	3000/4000	24400/25830	>70	T1	IP66	IK08	5 year
CAL-M180-T3A				23400/25200		T3A			



◀ CAL-S60



CAL-M120 ▶

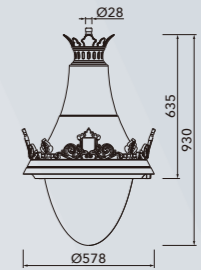

CAL-M

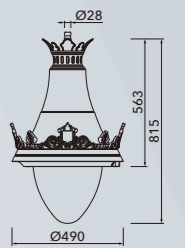

CAL-S





# FLOODLIGHTS

A range of floodlights and projectors suitable for any application, including uplighting of buildings, bridges and fascias.



**URBA**  
P82



**IPSES**  
P86

Power	40-480W	75-240W
CCT	3000/4000	4000/RGBW
Lumen Output	5130-69740	6800-24000



**DIVIO**  
P88



**RAVENNA**  
P90

Power	25-75W	18-75W
CCT	4000/RGBW	4000/RGBW
Lumen Output	2000-6170	1494-8250



**SUASA**  
P92



**GENUA & FLORENTIA**  
P94

Power	35-75W	9-23W
CCT	4000/RGBW	4000
Lumen Output	3290-7200	850-2150



**VECTIS**  
P96



**FINNIA**  
P100

Power	480-1800W	600-1500W
CCT	4000	3000/4000
Lumen Output	67200-241200	82800-205830



A high quality and stylish yet practical range of floodlights to match the URBA street lighting range. Four body sizes and outputs from 40W to 480W allow use for almost any application.

- Die-cast aluminium construction with a tempered glass diffuser.
- Optical lenses offer visual comfort and uniform light with multiple distribution options.
- The control gear housing is rated to IP66 and offers automatic isolation on opening.
- UV protected pure polyester powder coated housing offering high corrosion resistance.
- Suitable for use with a range of controls and remote management systems.
- All external screws are 304 stainless steel.
- RAL9007, other RAL colours available on request.



**URBA Range**  
Page 22

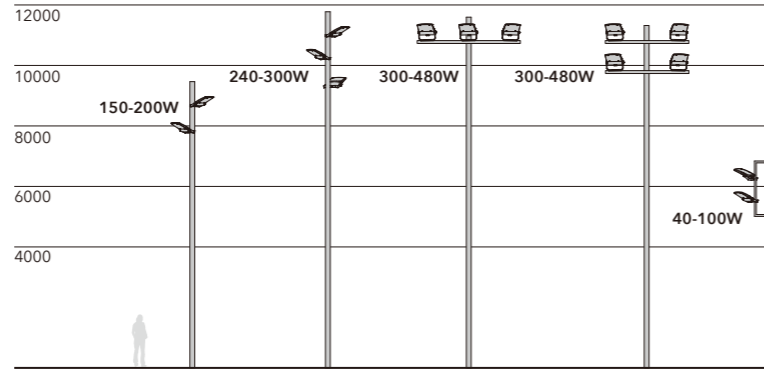

CODE	POWER	LED PCS	CCT	LUMEN OUTPUT	CRI	BEAM ANGLE	IP	IK	WARRANTY
URB-FL-XS40-T3A	40W	24	3000/4000	5130/5500	>70	T3A	IP66	IK08	5 year
URB-FL-XS40-T90				5320/5720		T90			
URB-FL-XS60-T3A	60W	24	3000/4000	7560/8100	>70	T3A	IP66	IK08	5 year
URB-FL-XS60-T90				8040/8420		T90			
URB-FL-XS100-T3A	100W	36	3000/4000	12800/13890	>70	T3A	IP66	IK08	5 year
URB-FL-XS100-T90				13660/14730		T90			
URB-FL-S150-T3A	150W	48	3000/4000	19850/21540	>70	T3A	IP66	IK08	5 year
URB-FL-S150-T4A				19950/21430		T4A			
URB-FL-S150-T90				20520/22240		T90			
URB-FL-S200-T3D	200W	72	3000/4000	25890/28120	>70	T3D	IP66	IK08	5 year
URB-FL-S200-T4D				26180/28240		T4D			
URB-FL-S200-T90D				28630/30920		T90D			
URB-FL-M240-T3A	240W	80	3000/4000	31960/34220	>70	T3A	IP66	IK08	5 year
URB-FL-M240-T4A				31400/33910		T4A			
URB-FL-M240-T90				33620/36070		T90			
URB-FL-M300-T3A	300W	96	3000/4000	39780/42450	>70	T3A	IP66	IK08	5 year
URB-FL-M300-T4A				39480/42390		T4A			
URB-FL-M300-T90				42570/45690		T90			
URB-FL-L400-T3A	400W	144	3000/4000	52080/56080	>70	T3A	IP66	IK08	5 year
URB-FL-L400-T4A				51680/55200		T4A			
URB-FL-L400-T90				56800/60120		T90			
URB-FL-L480-T3A	480W	168	3000/4000	62680/67340	>70	T3A	IP66	IK08	5 year
URB-FL-L480-T4A				62640/67310		T4A			
URB-FL-L480-T90				65070/69740		T90			



**URB-FL-XS40**



**URB-FL-S150**



**URB-FL-L400**



**URB-FL-M240**

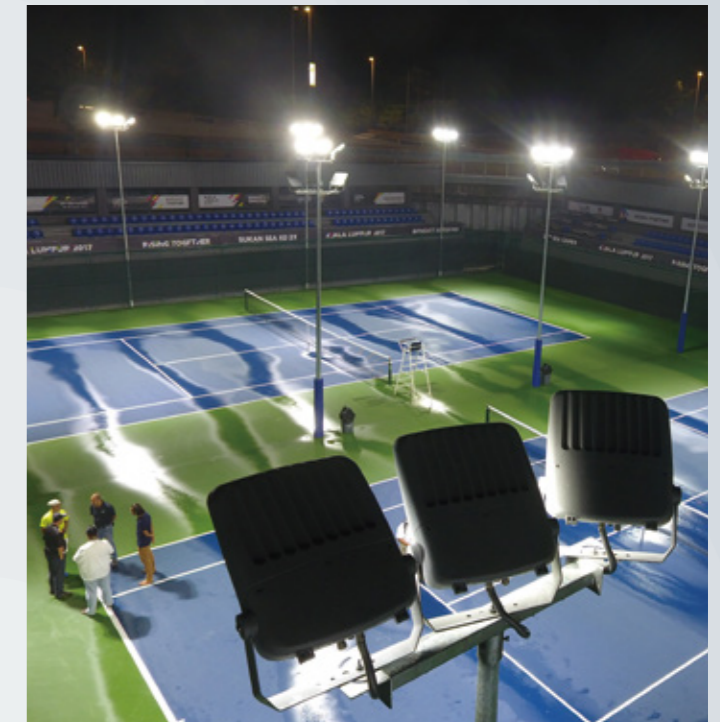



Safety rope available to prevent unexpected falling of the luminaire in the event of significant impact or extreme weather conditions.

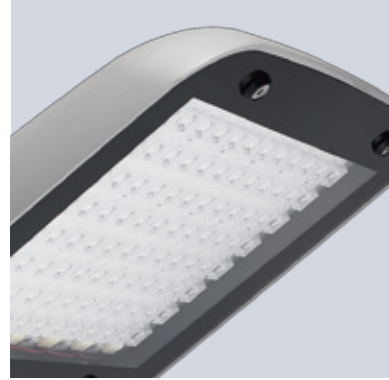

IK08 tempered glass lens with anti-tamper screws. Zhaga standard PCB boards and modular lenses allows for different optics to meet the requirements of the application.



IP66 control gear housing with automatic disconnection of power supply for additional safety.

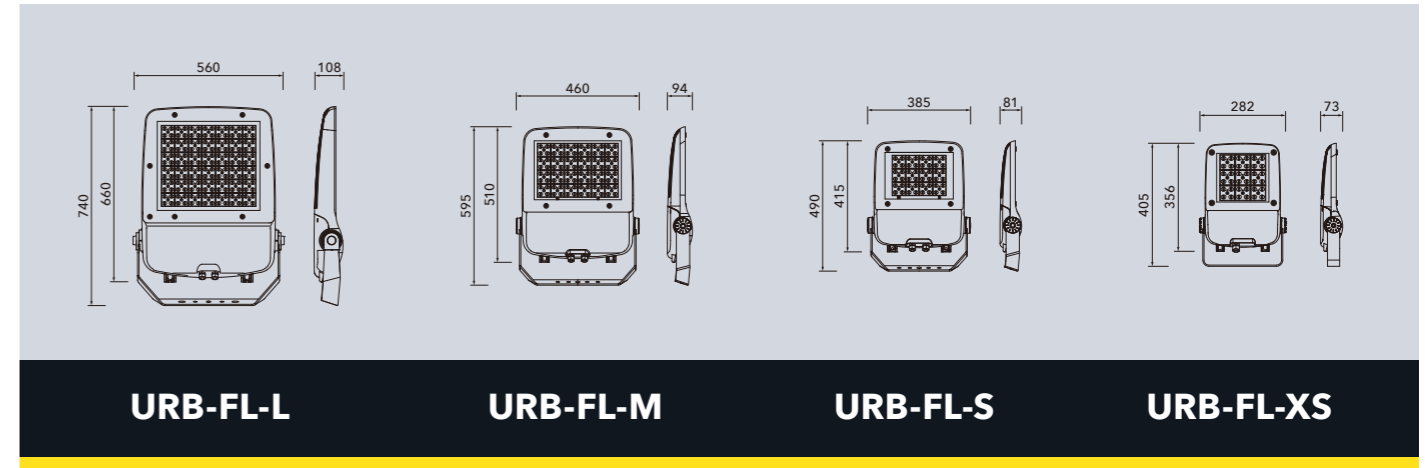

A specially designed heat sink allows good heat dissipation while preventing a build up of dirt and grime.



Large body has a stainless steel angle adjustment plate to ensure optimum direction of the light source.



Other body sizes have the angle adjustment moulded into the die-cast bracket.

A classic round floodlight suitable for use in a variety of applications. Two sizes and a range of outputs and an RGBW option ensure versatility of the range.

- Die-cast aluminium construction with tempered glass diffuser and two size options.
- Optical lenses offer visual comfort and uniform light distribution.
- High quality LED chips and driver with RGBW options in each size.
- Suitable for a variety of installation methods to meet the requirements of the application.
- Visors available as accessories.
- UV protected pure polyester powder coated housing offering high corrosion resistance.
- All external screws are 304 stainless steel.
- RAL9007, other RAL colours available on request.

### Accessories



Visor accessory

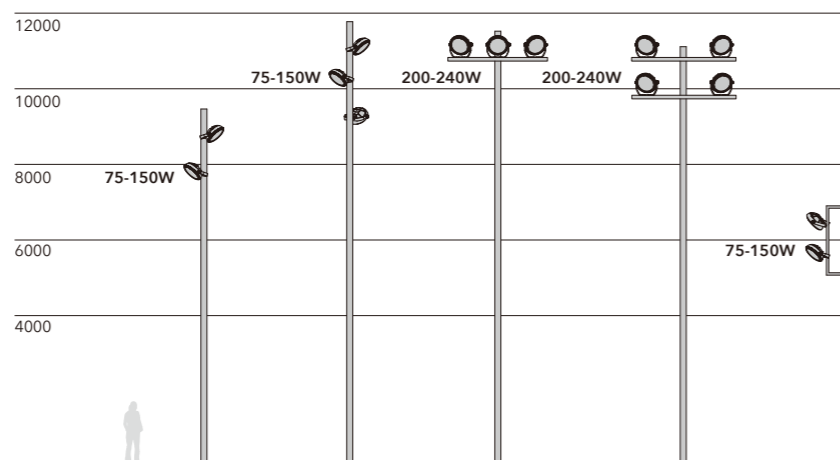

CODE	POWER	LED PCS	CCT	LUMEN OUTPUT	CRI	BEAM ANGLE	IP	IK	WARRANTY
IPS-S75-TS25	75W	24	4000	7700	>70	TS25	IP66	IK09	5 year
IPS-S100-TS25	100W	36	4000	11000	>70	TS25	IP66	IK09	5 year
IPS-S120-TS25	120W	36	4000	13200	>70	TS25	IP66	IK09	5 year
IPS-S150-TS25-RGBW	150W	36	RGBW	11250	>70	TS25	IP66	IK09	5 year
IPS-M150-TS25	150W	60	4000	18000	>70	TS25	IP66	IK09	5 year
IPS-M200-TS25	200W	84	4000	24000	>70	TS25	IP66	IK09	5 year
IPS-M240-TS25-RGBW	240W	84	RGBW	17520	>70	TS25	IP66	IK09	5 year



**IPS-M150**



**IPS-S75**

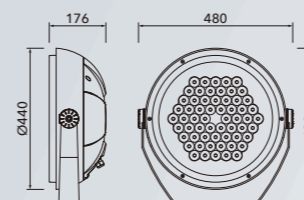

IPS-M

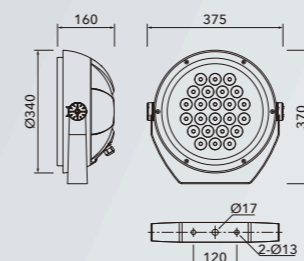

IPS-S



A modern and stylish projector style floodlight ideal for a range of applications and available in two sizes with an RGBW option ensure versatility of the range.

- Die-cast aluminium construction with tempered glass diffuser and two size options.
- Optical lenses offer visual comfort and uniform light distribution.
- High quality LED chips and driver with RGBW options in each size.
- Suitable for a variety of installation methods to meet the requirements of the application.
- Spill ring and honeycomb louvres available as accessories.
- UV protected pure polyester powder coated housing offering high corrosion resistance.
- All external screws are 304 stainless steel.
- RAL9007, other RAL colours available on request.

### Accessories

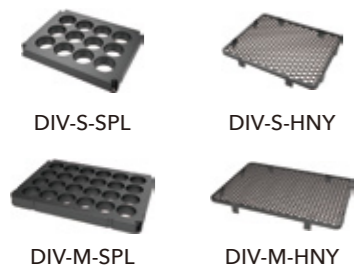

CODE	POWER	LED PCS	CCT	LUMEN OUTPUT	CRI	BEAM ANGLE	IP	IK	WARRANTY
DIV-S25-TS25	25W	12	4000	2050	>80	TS25	IP66	IK09	5 year
DIV-S40-TS25	40W	12	4000	3120	>80	TS25	IP66	IK09	5 year
DIV-S50-TS25-RGBW	50W	12	RGBW	3500	>80	TS25	IP66	IK09	5 year
DIV-M50-TS25	50W	24	4000	4300	>80	TS25	IP66	IK09	5 year
DIV-M75-TS25	75W	24	4000	6170	>80	TS25	IP66	IK09	5 year
DIV-M75-TS25-RGBW	75W	24	RGBW	5850	>80	TS25	IP66	IK09	5 year



**DIV-M50**



**DIV-S25**

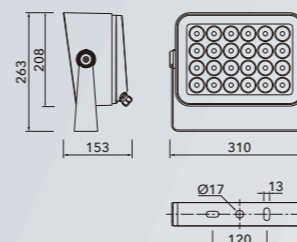

DIV-M

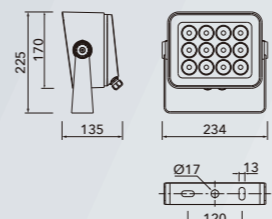

DIV-S



A range of round projector floodlights that are ideal for uplighting building facades, bridges and trees. Three sizes and a range of outputs with RGBW options ensure versatility of the range.

- Die-cast aluminium construction with tempered glass diffuser and two size options.
- Optical lenses offer visual comfort and uniform light distribution.
- High quality LED chips and driver with RGBW options in each size.
- UV protected pure polyester powder coated housing offering high corrosion resistance.
- All external screws are 304 stainless steel.
- RAL9005, other RAL colours available on request.

### Accessories

-  Pole Clamp
-  Pole Bracket
-  Ø48mm Fixing Arm

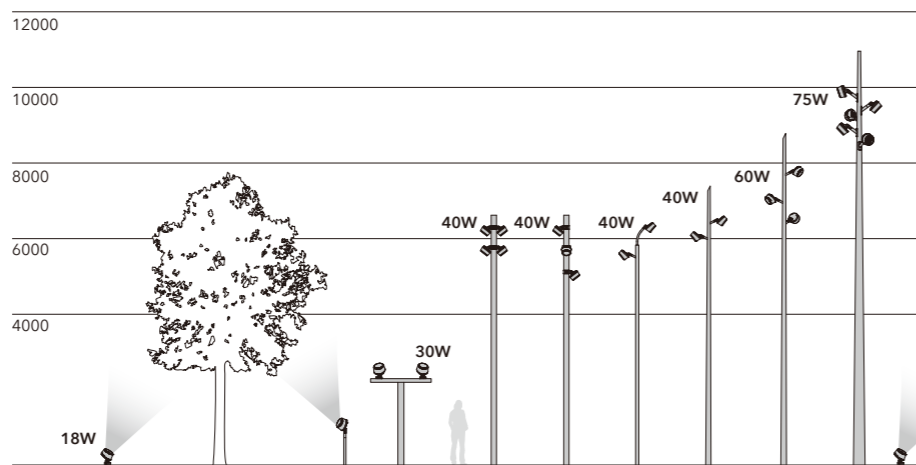

CODE	POWER	LED PCS	CCT	LUMEN OUTPUT	CRI	BEAM ANGLE	IP	IK	WARRANTY
RAV-S18-TP25	18W	6	4000	1720	>80	TP25	IP66	IK09	5 year
RAV-S18-TP25-RGBW	18W	6	RGBW	1494	>80	TP25	IP66	IK09	5 year
RAV-M30-TS25	30W	12	4000	3010	>80	TS25	IP66	IK09	5 year
RAV-M40-TS25	40W	12	4000	3600	>80	TS25	IP66	IK09	5 year
RAV-M40-TS25-RGBW	40W	12	RGBW	3400	>80	TS25	IP66	IK09	5 year
RAV-L60-TS25	60W	18	4000	6780	>80	TS25	IP66	IK09	5 year
RAV-L80-TS25	80W	18	4000	8250	>80	TS25	IP66	IK09	5 year
RAV-L80-TS25-RGBW	80W	18	RGBW	6225	>80	TS25	IP66	IK09	5 year



 **RAV-S18**



 **RAV-M30**



 **RAV-L60**

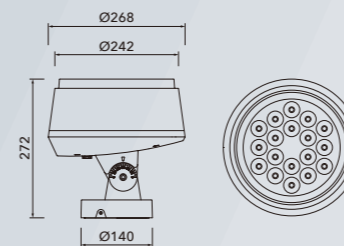

RAV-L

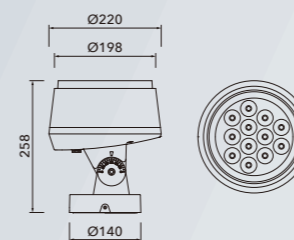

RAV-M

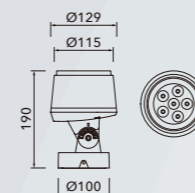

RAV-S



A unique projector floodlight designed exclusively for uplighting trees and building facades. Two sizes and multiple outputs, including RGBW options.

- Die-cast aluminium construction with tempered glass diffuser and two size options.
- Optical lenses offer visual comfort and uniform light distribution.
- High quality LED chips and driver with RGBW options in each size.
- UV protected pure polyester powder coated housing offering high corrosion resistance.
- Honeycomb louvre accessory available.
- All external screws are 304 stainless steel.
- RAL9007, other RAL colours available on request.



**SUA-M60**



**SUA-S35**

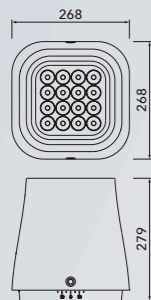

SUA-M

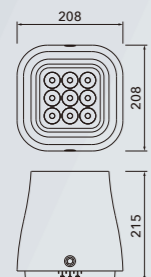

SUA-S



Adjustable tilt and rotation feature to ensure optimum distribution of light.

**Accessories**



SUA-S-HNY



SUA-M-HNY

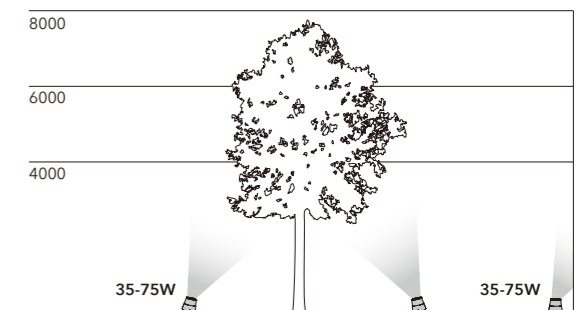

CODE	POWER	LED PCS	CCT	LUMEN OUTPUT	CRI	BEAM ANGLE	IP	IK	WARRANTY
SUA-S35-TS15	35W	9	4000	3290	>80	TS15	IP66	IK09	5 year
SUA-S50-TS15	50W	9	4000	4000	>80	TS15	IP66	IK09	5 year
SUA-S50-TS15-RGBW	50W	9	RGBW	4150	>80	TS15	IP66	IK09	5 year
SUA-M60-TS15	60W	16	4000	5880	>80	TS15	IP66	IK09	5 year
SUA-M75-TS15	75W	16	4000	7200	>80	TS15	IP66	IK09	5 year
SUA-M75-TS15-RGBW	75W	16	RGBW	6300	>80	TS15	IP66	IK09	5 year

# LEDSCAPE® GENUA & FLORENTIA FLOOD LIGHT

THE POWER OF LIGHT

Round and square projector floodlights suitable for a range of applications and installation methods. Two sizes in each style and a variety range of installation accessories available.

- Die-cast aluminium construction with tempered glass diffuser and two size options.
- Optical lenses offer visual comfort and uniform light distribution.
- High quality LED chips and driver.
- UV protected pure polyester powder coated housing offering high corrosion resistance.
- All external screws are in 304 stainless steel.
- RAL9007, other RAL colours available on request.

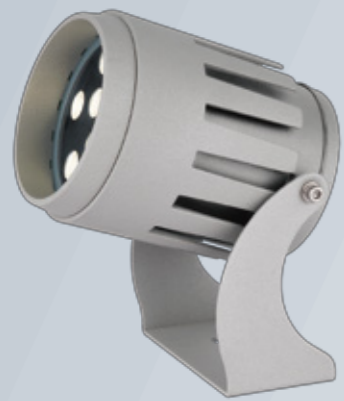

**GEN-M23**



**GEN-S9**



**FLO-M23**



**FLO-S12**

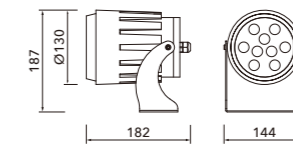

**GEN-M23**

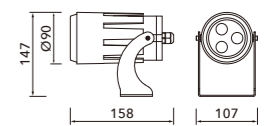

**GEN-S9**

### Accessories

- Spike
- Anchor Bolts
- Expansion Bolts

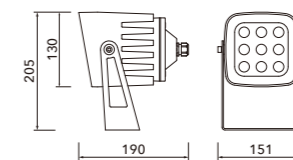

**FLO-M23**

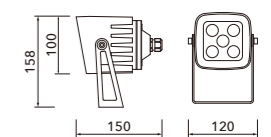

**FLO-S12**

CODE	POWER	LED PCS	CCT	LUMEN OUTPUT	CRI	BEAM ANGLE	IP	IK	WARRANTY
GEN-S9-TP25	9W	3	4000	850	>70	TP25	IP65	IK08	5 year
GEN-M23-TP25	23W	9	4000	2150	>70	TP25	IP65	IK08	5 year
FLO-S12-TP25	12W	4	4000	1100	>70	TP25	IP65	IK08	5 year
FLO-M23-TP25	23W	9	4000	2150	>70	TP25	IP65	IK08	5 year





VECS-S480



VECS-M1000



VECS-L1500



A high quality, stadium level sports floodlight with TLCI (Television Lighting Consistency Index) and available in a range of sizes to suit applications from a single tennis court to an international football stadium.

- Die-cast aluminium housing with tempered glass diffuser and a separate driver housing.
- Optical reflector design with high visual comfort and uniform light distribution.
- IP66 rated control gear housing with safe disconnection methods for easy maintenance.
- UV protected pure polyester powder coated housing offering high corrosion resistance.
- All external screws are 304 stainless steel.
- RAL9007, other RAL colours available on request.



Accessories



VEC-VIS

CODE	POWER	LED PCS	CCT	LUMEN OUTPUT	CRI	BEAM ANGLE	IP	IK	WARRANTY
VECS-S480-T50	480W	192	4000	67200	>70	T50	IP66	IK08	5 year
VECS-S600-T50	600W	192	4000	80400	>70	T50	IP66	IK08	5 year
VECS-M1000-T50	1000W	384	4000	138000	>70	T50	IP66	IK08	5 year
VECS-M1200-T50	1200W	384	4000	159670	>70	T50	IP66	IK08	5 year
VECS-L1500-T50	1500W	576	4000	207010	>70	T50	IP66	IK08	5 year
VECS-L1800-T50	1800W	576	4000	241200	>70	T50	IP66	IK08	5 year



Highly engineered heat dissipation system to allow optimum thermal management and guarantee excellent and long term performance. Each module can be adjusted slightly for accurate light distribution.



Intelligent integrated driver

DMX DALI

Separate driver housing from main light source to ensure air flow and performance.

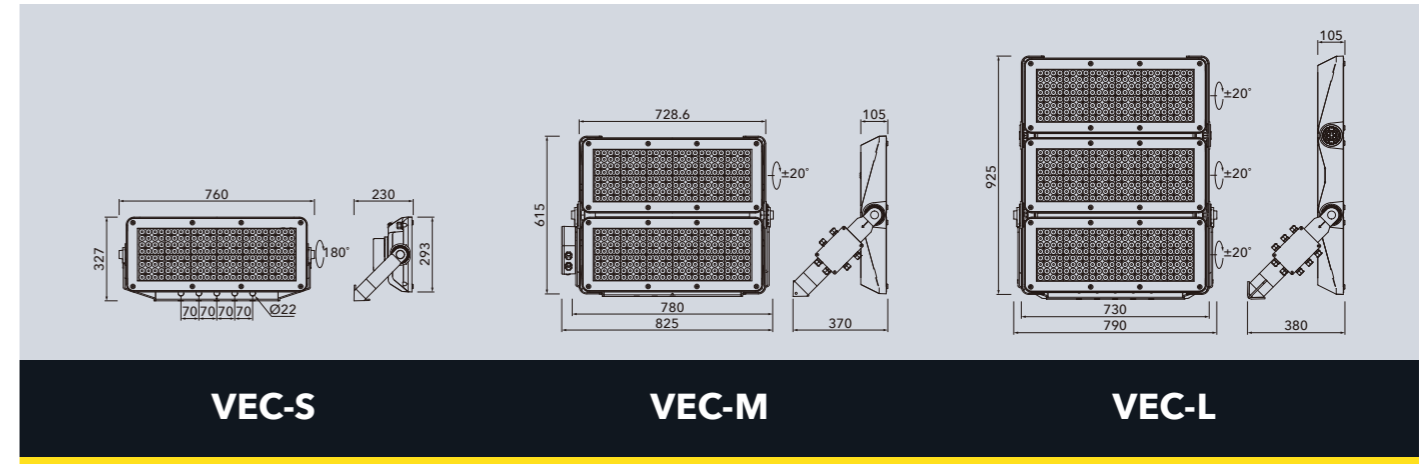

Stainless steel angle adjustment plate to ensure optimum direction of the light source.



◀ **FIN-S600**



**FIN-M800** ▶



◀ **FIN-L1200**



A high quality, stadium level sports floodlight with TLCI (Television Lighting Consistency Index) and available in a range of sizes to suit applications from a single tennis court to an international football stadium.

- Die-cast aluminium housing with polycarbonate lenses and a separate driver housing.
- Optical lenses with high visual comfort and uniform light distribution.
- IP66 rated control gear housing with safe disconnection methods for easy maintenance.
- UV protected pure polyester powder coated housing offering high corrosion resistance.
- All external screws are 304 stainless steel.
- RAL9007, other RAL colours available on request.



Accessories



Visor accessory

CODE	POWER	LED PCS	CCT	LUMEN OUTPUT	CRI	BEAM ANGLE	IP	IK	WARRANTY
FIN-S600-TM6	600W	198	3000/4000	82800/87000	>70	TM6A66	IP66	IK10	5 year
FIN-S680-TM6	680W	198	3000/4000	91120/96560	>70	TM6A66	IP66	IK10	5 year
FIN-M800-TM6	800W	264	3000/4000	110400/116000	>70	TM6A66	IP66	IK10	5 year
FIN-M1000-TM6	1000W	264	3000/4000	128090/137730	>70	TM6A66	IP66	IK10	5 year
FIN-L1200-TM6	1200W	396	3000/4000	165600/174000	>70	TM6A66	IP66	IK10	5 year
FIN-L1500-TM6	1500W	396	3000/4000	191420/205830	>70	TM6A66	IP66	IK10	5 year



Highly engineered heat dissipation system to allow optimum thermal management and guarantee excellent and long term performance. Each module can be adjusted slightly for accurate light distribution.

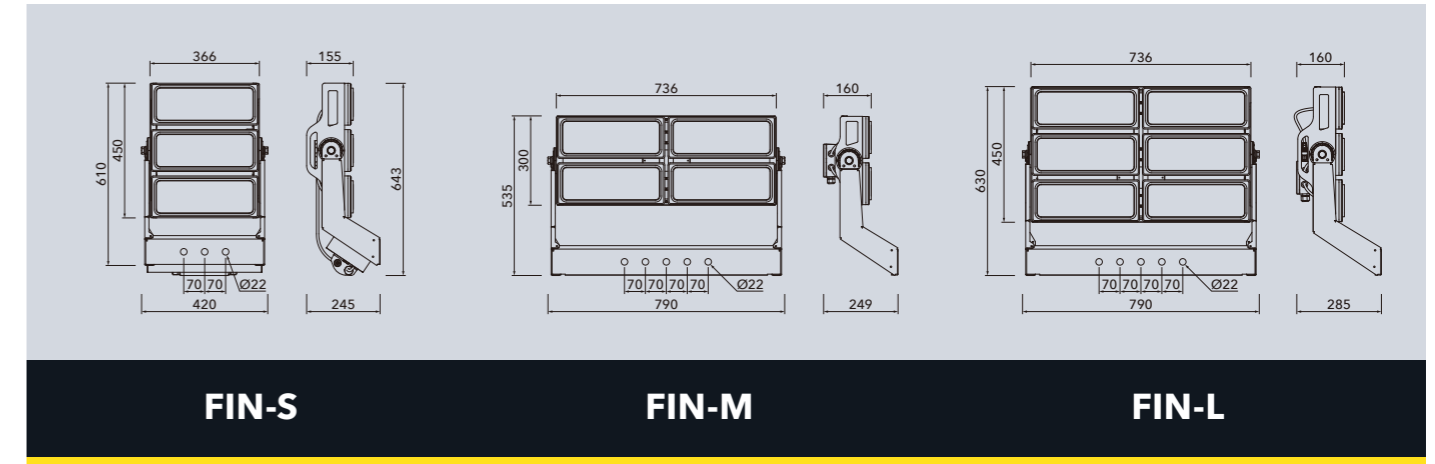

Separate driver housing from main light source to ensure air flow and performance.



Optional visor accessory available.



## BOLLARDS

A range of high-quality die-cast bollards ideal for illuminating pathways, driveways and pedestrian areas.



**SALA**  
P106



**LIPSIA**  
P108



**BREMA**  
P110

Power	12W	25W	25W
CCT	4000	3000/4000	3000/4000
Lumen Output	1060	2210/2380	2340/2370



**TOLOSA**  
P112



**NICIA**  
P114



**GALLIA**  
P116

Power	25W	15-30W	15W
CCT	3000/4000	3000/4000	3000
Lumen Output	950/1000	1470-2940	1050

A modern and stylish bollard available in three heights to suit a variety of applications, and with an indirect light source to reduce glare.

- Aluminium die-cast lamp head and extruded aluminium body, available in three heights.
- High transparency polycarbonate diffuser.
- Indirect light source offering high visual comfort and even light distribution.
- High quality LED chips and driver.
- UV protected pure polyester powder coated housing offering high corrosion resistance.
- Interior and exterior flange options.
- SAL-12 in RAL9007, SAL-F-12 in RAL9005. Other RAL colours available on request.



**SALA Range**  
Page 120

CODE	POWER	LED PCS	CCT	LUMEN OUTPUT	CRI	BEAM ANGLE	IP	IK	WARRANTY
SAL-12-160-60	12W	5	4000	1060	>70	160°	IP65	IK09	5 year
SAL-12-160-80	12W	5	4000	1060	>70	160°	IP65	IK09	5 year
SAL-12-160-100	12W	5	4000	1060	>70	160°	IP65	IK09	5 year
SAL-F-12-160-60	12W	5	4000	1060	>70	160°	IP65	IK09	5 year
SAL-F-12-160-80	12W	5	4000	1060	>70	160°	IP65	IK09	5 year
SAL-F-12-160-100	12W	5	4000	1060	>70	160°	IP65	IK09	5 year



**SAL-F-12**

**SAL-12**

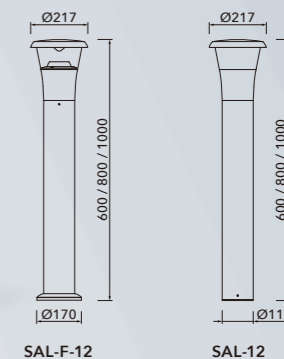

SAL-F-12

SAL-12

SAL



A modern take on the traditional bollard available in two heights to suit a variety of applications, and with an indirect light source to reduce glare.

- Aluminium die-cast lamp head and extruded aluminium body, available in two heights.
- High transparency polycarbonate diffuser.
- Indirect light source offering high visual comfort and even light distribution.
- High quality LED chips and driver.
- UV protected pure polyester powder coated housing offering high corrosion resistance.
- Integrated switch to select colour temperature between 3000K and 4000K.
- RAL9005, other RAL colours available on request.



**LIP-25**

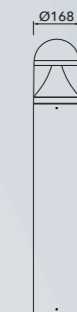

LIP



CODE	POWER	LED PCS	CCT	LUMEN OUTPUT	CRI	BEAM ANGLE	IP	IK	WARRANTY
LIP-25-130-80	25W	132	3000/4000	2210/2380	>70	130°	IP65	IK09	5 year
LIP-25-130-100	25W	132	3000/4000	2210/2380	>70	130°	IP65	IK09	5 year

A modern take on the traditional bollard available in two heights to suit a variety of applications, and with an indirect light source to reduce glare.

- Aluminium die-cast lamp head and extruded aluminium body, available in two heights.
- High transparency polycarbonate diffuser.
- Indirect light source offering high visual comfort and even light distribution.
- High quality LED chips and driver.
- UV protected pure polyester powder coated housing offering high corrosion resistance.
- Integrated switch to select colour temperature between 3000K and 4000K.
- RAL9005, other RAL colours available on request.



**BRE-25**



BRE



**BREMA Range**  
Page 122

CODE	POWER	LED PCS	CCT	LUMEN OUTPUT	CRI	BEAM ANGLE	IP	IK	WARRANTY
BRE-25-130-80	25W	132	3000/4000	2340/2370	>70	130°	IP65	IK09	5 year
BRE-25-130-100	25W	132	3000/4000	2340/2370	>70	130°	IP65	IK09	5 year



A modern take on the traditional bollard available in two heights to suit a variety of applications, and with an indirect light source and louvred reflector to reduce glare.

- Aluminium die-cast lamp head and extruded aluminium body, available in two heights.
- High transparency polycarbonate diffuser.
- Indirect light source and louvred reflector offering high visual comfort, low glare and even light distribution.
- High quality LED chips and driver.
- UV protected pure polyester powder coated housing offering high corrosion resistance.
- Integrated switch to select colour temperature between 3000K and 4000K.
- RAL9005, other RAL colours available on request.



◀ TOL-25



TOL



CODE	POWER	LED PCS	CCT	LUMEN OUTPUT	CRI	BEAM ANGLE	IP	IK	WARRANTY
TOL-25-130-80	25W	144	3000/4000	950/1000	>70	130°	IP65	IK09	5 year
TOL-25-130-100	25W	144	3000/4000	950/1000	>70	130°	IP65	IK09	5 year

A modern and stylish square bollard available in two heights and two outputs to suit a variety of applications, and with an indirect light source to reduce glare.

- Aluminium die-cast lamp head and extruded aluminium body, available in two heights.
- High transparency polycarbonate diffuser.
- Indirect light source offering high visual comfort and even light distribution.
- High quality LED chips and driver.
- UV protected pure polyester powder coated housing offering high corrosion resistance.
- Integrated switch to select colour temperature between 3000K and 4000K.
- RAL9007, other RAL colours available on request.



**NIC-30**

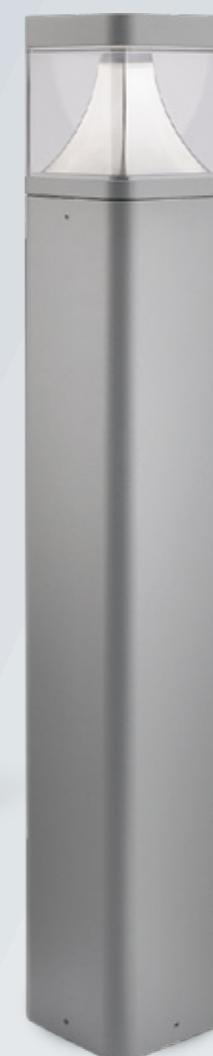

**NIC-15**

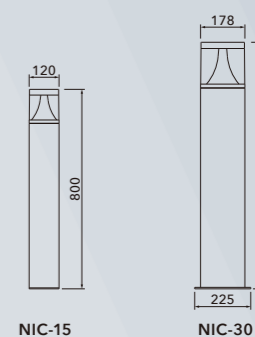

NIC-15

NIC-30

NIC



CODE	POWER	LED PCS	CCT	LUMEN OUTPUT	CRI	BEAM ANGLE	IP	IK	WARRANTY
NIC-15-140	15W	132	3000/4000	1470/1530	>70	140°	IP65	IK09	5 year
NIC-30-140	30W	168	3000/4000	2820/2940	>70	140°	IP65	IK09	5 year

A modern and decorative bollard available in three heights and with an asymmetric light distribution offering very low upwards light. Taller versions also available for pedestrian areas.

- Aluminium die-cast lamp head and extruded aluminium body, available in three heights.
- High transparency polycarbonate diffuser.
- Asymmetric light source for optimum performance and reduced light pollution.
- High quality LED chips and driver.
- UV protected pure polyester powder coated housing offering high corrosion resistance.
- RAL9007, other RAL colours available on request.



**GALLIA Range**

Page 54

CODE	POWER	LED PCS	CCT	LUMEN OUTPUT	CRI	BEAM ANGLE	IP	IK	WARRANTY
GAL-H60-15-130	15W	5	3000	1050	>70	130°	IP66	IK09	5 year
GAL-H80-15-130	15W	5	3000	1050	>70	130°	IP66	IK09	5 year
GAL-H100-15-130	15W	5	3000	1050	>70	130°	IP66	IK09	5 year



**GAL-H100**

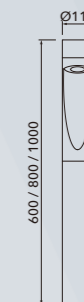

**GAL**





## WALL LIGHTING

A range of high quality and stylish wall lights to cover a wide variety of applications from residential apartment buildings to large scale commercial and industrial buildings.



**SALA**  
P120



**BREMA**  
P122



**GAZA**  
P124

Power	12W	12W	12-80W
CCT	4000	3000/4000	4000
Lumen Output	1060	1050/1080	960-8400



**ISCA**  
P126



**ASSOS**  
P128



**CANTABRIGIA**  
P130

Power	25W	10-36W	5-28W
CCT	4000	3000	3000/4000
Lumen Output	2150	990-4100	550-3500



**REVALIA**  
P132



**SPARTA**  
P134



**ARGOS**  
P136

Power	14W	40W	22W
CCT	4000	4000	3000/4000
Lumen Output	690-950	2400	1500/1500

A stylish wall lantern with an indirect light source to give a pleasant lighting effect, with a matching bollard range available. Ideal for residential and public recreation areas.

- Die-cast aluminium body and mounting plate.
- Highly transparent polycarbonate diffuser.
- Indirect light source offering high visual comfort and even light distribution.
- High quality LED chips and driver.
- UV protected pure polyester powder coated housing offering high corrosion resistance.
- RAL9005, other RAL colours available on request.



**SAL-WL-12**

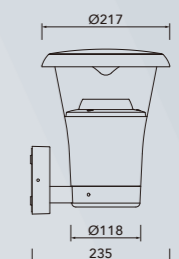

SAL



**SALA Range**  
Page 106



CODE	POWER	LED PCS	CCT	LUMEN OUTPUT	CRI	BEAM ANGLE	IP	IK	WARRANTY
SAL-WL-12-160	12W	5	4000	1060	>70	160°	IP65	IK09	5 year

A stylish wall lantern with an indirect light source to give a pleasant lighting effect, with a matching bollard range available. Ideal for residential and public recreation areas.

- Die-cast aluminium body and mounting plate.
- Highly transparent polycarbonate diffuser.
- Indirect light source offering high visual comfort and even light distribution.
- High quality LED chips and driver.
- UV protected pure polyester powder coated housing offering high corrosion resistance.
- Integrated switch to select colour temperature between 3000K and 4000K.
- RAL9005, other RAL colours available on request.

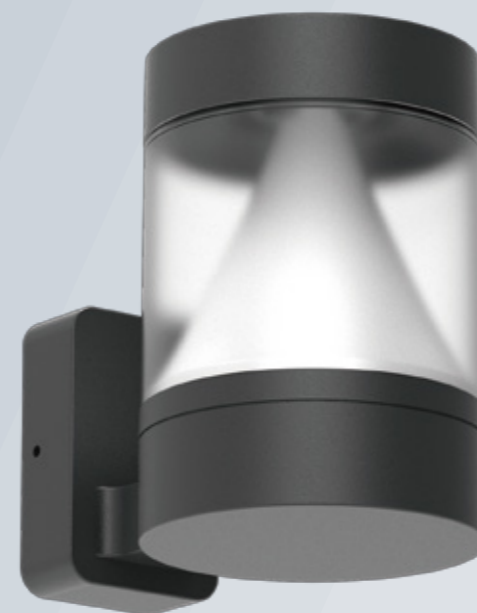

**BRE-12**

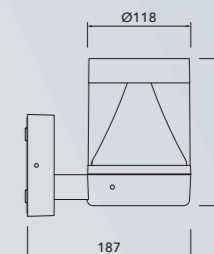

BRE



**BREMA Range**  
Page 110

CODE	POWER	LED PCS	CCT	LUMEN OUTPUT	CRI	BEAM ANGLE	IP	IK	WARRANTY
BRE-12-360	12W	56	3000/4000	1050/1080	>70	360°	IP65	IK09	5 year

High quality wall light with both down only and up and down lighting options for versatility, and available in three sizes to cover a variety of applications.

- Die-cast aluminium base with extruded aluminium body.
- Super white tempered glass lens offering high visual comfort.
- UV protected pure polyester powder coated housing offering high corrosion resistance.
- High quality LED chips and driver.
- Up and down and down only lighting options.
- RAL9005, other RAL colours available on request.



GAZ-S12

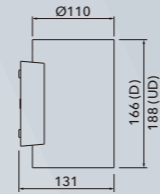

GAZ-S



GAZ-M18

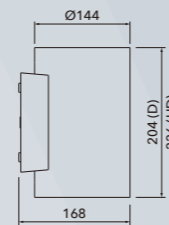

GAZ-M



GAZ-L40

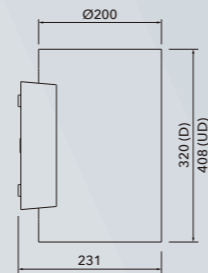

GAZ-L



CODE	POWER	LED PCS	CCT	LUMEN OUTPUT	CRI	BEAM ANGLE	IP	IK	WARRANTY
GAZ-S12-80-D	12W	1	4000	960	>70	80°	IP65	IK08	5 year
GAZ-S18-80-UD	18W	2	4000	1560	>70	80°	IP65	IK08	5 year
GAZ-M18-80-D	18W	1	4000	1940	>70	80°	IP65	IK08	5 year
GAZ-M40-80-UD	40W	2	4000	4360	>70	80°	IP65	IK08	5 year
GAZ-L40-36-D	40W	1	4000	4000	>70	36°	IP65	IK08	5 year
GAZ-L80-36-UD	80W	2	4000	8400	>70	36°	IP65	IK08	5 year



ISC-25

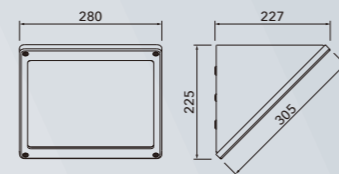

ISC



A minimalistic yet contemporary wall light that offers durability and comfort. Ideal for perimeter lighting and in walkways or stairwells.

- Die-cast aluminium body with prism tempered glass offering uniform light distribution.
- High quality LED chips and driver.
- High impact resistance and stainless steel anti-tamper screws.
- UV protected pure polyester powder coated housing offering high corrosion resistance.
- RAL9005, other RAL colours available on request.

CODE	POWER	LED PCS	CCT	LUMEN OUTPUT	CRI	BEAM ANGLE	IP	IK	WARRANTY
ISC-25-100	25W	132	4000	2150	>70	100°	IP65	IK08	5 year



High quality square wall light with both down only and up and down lighting options for versatility, and available in two sizes to cover a variety of applications.

- Die-cast aluminium base with extruded aluminium body.
- Super white tempered frosted glass lens offering high visual comfort.
- UV protected pure polyester powder coated housing offering high corrosion resistance.
- High quality LED chips and driver.
- Up and down and down only lighting options.
- RAL9005, other RAL colours available on request.

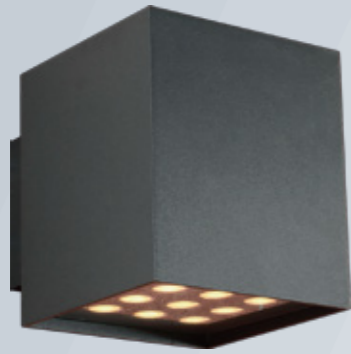

**ASS-M36**



**ASS-S10**

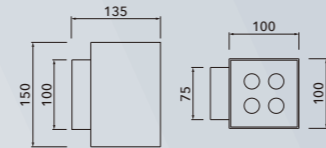

ASS-S

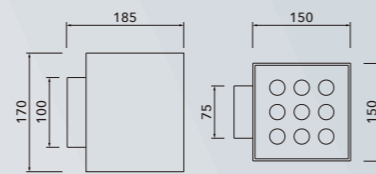

ASS-M



CODE	POWER	LED PCS	CCT	LUMEN OUTPUT	CRI	BEAM ANGLE	IP	IK	WARRANTY
ASS-S10-TP25-D	10W	4	3000	990	>70	TP25	IP65	IK08	5 year
ASS-S20-TP25-UD	20W	8	3000	2300	>70	TP25	IP65	IK08	5 year
ASS-M23-TP25-D	23W	9	3000	2350	>70	TP25	IP65	IK08	5 year
ASS-M36-TP25-UD	36W	18	3000	4100	>70	TP25	IP65	IK08	5 year

A unique design wall light with selectable outputs and colour temperature and with minimal upward light available in three sizes. Ideal for residential and commercial applications.

- Die-cast aluminium body with lightly frosted polycarbonate diffuser.
- High quality LED chips and driver.
- Selectable lumen outputs and colour temperature to suit the application.
- UV protected pure polyester powder coated housing offering high corrosion resistance.
- RAL9005, other RAL colours available on request.

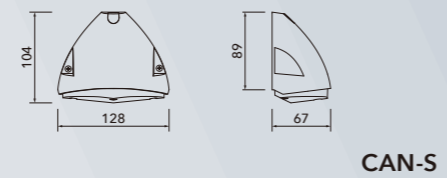
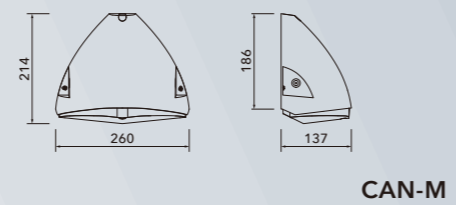
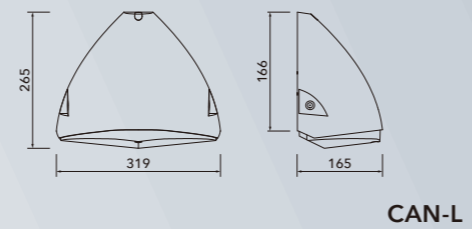

CODE	POWER	LED PCS	CCT	LUMEN OUTPUT	CRI	BEAM ANGLE	IP	IK	WARRANTY
CAN-S5-120	5W	10	3000/4000	550-580	>80	120°	IP65	IK10	5 year
CAN-M12-120	7-12W	66	3000/4000	950-1550	>80	120°	IP65	IK10	5 year
CAN-M12-120-EM	7-12W	66	3000/4000	950-1550	>80	120°	IP65	IK10	5 year
CAN-L28-120	13-28W	132	3000/4000	1700-3500	>80	120°	IP65	IK10	5 year
CAN-L28-120-EM	13-28W	132	3000/4000	1700-3500	>80	120°	IP65	IK10	5 year

A heavy duty yet stylish bulkhead ideal for amenity lighting applications. Plain trim and eyelid versions available.

- Die-cast aluminium body with impact resistant polycarbonate diffuser.
- High quality LED chips and driver.
- IK10 impact rating with anti-tamper screws.
- UV protected pure polyester powder coated housing offering high corrosion resistance.
- RAL9005, other RAL colours available on request.



**REV-14**



**REV-14-EL**

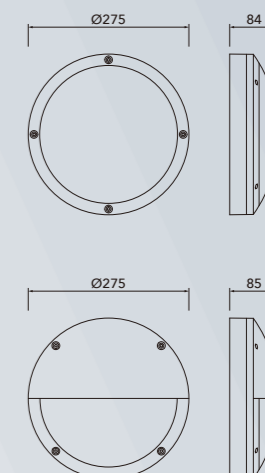

REV



CODE	POWER	LED PCS	CCT	LUMEN OUTPUT	CRI	BEAM ANGLE	IP	IK	WARRANTY
REV-14-120	14W	132	4000	950	>80	120°	IP65	IK10	5 year
REV-14-120-EL	14W	132	4000	690	>80	120°	IP65	IK10	5 year

A modern take on the traditional wall pack with an indirect light source that offers a classic appearance, ideal for commercial applications.

- Die- cast aluminium base with prismatic polycarbonate diffuser.
- High quality LED chips and driver.
- Opal cover over light source.
- UV protected pure polyester powder coated housing offering high corrosion resistance.
- RAL9005, other RAL colours available on request.



**SPA-40**

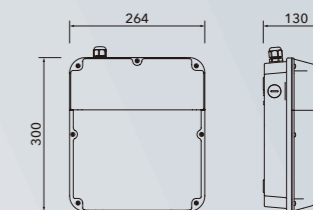

SPA



CODE	POWER	LED PCS	CCT	LUMEN OUTPUT	CRI	BEAM ANGLE	IP	IK	WARRANTY
SPA-40-120	40W	132	4000	2400	>80	120°	IP65	IK08	5 year

A slim and stylish polycarbonate wall pack luminaire that is ideal for residential and commercial amenity lighting applications.

- Polycarbonate base, diffuser and cover offering uniform light distribution.
- High quality LED chips and driver.
- Adjustable colour temperature to suit different applications.
- UV stabilised polycarbonate to prevent discolouring.
- RAL9005, other RAL colours available on request.



**ARG-22**

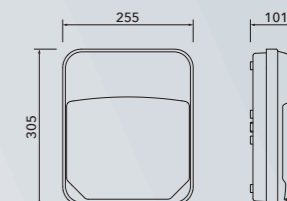

ARG



CODE	POWER	LED PCS	CCT	LUMEN OUTPUT	CRI	BEAM ANGLE	IP	IK	WARRANTY
ARG-22-120	22W	132	3000/4000	1500/1500	>80	120°	IP65	IK08	5 year

# CEILING LIGHTS

A range of ceiling mounted luminaires that can be installed both inside and outside. Ideal for canopies and walkways as well as amenity lighting.



**AVENIO**

P140



**CASTRA**

P142

Power	12-23W	9-36W
CCT	4000	4000
Lumen Output	1280-2650	770-3730



**CILPES**

P144



**ESPO**

P146

Power	25W	15-25W
CCT	4000	4000
Lumen Output	2400	1500-2500



An attractive square ceiling light available in two sizes and rated to IP65 for outdoor use. Frosted tempered glass lenses offer security and reduced glare.

- Die-cast aluminium base with extruded aluminium alloy body.
- Super white frosted tempered glass lens offering high visual comfort and even light distribution.
- UV protected pure polyester powder coated housing offering high corrosion resistance.
- High quality LED chips and driver.
- RAL9007, other RAL colours available on request.



**AVE-S12**



**AVE-M23**

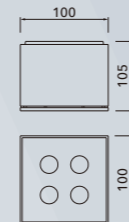

AVE-S

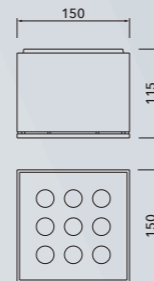

AVE-M



CODE	POWER	LED PCS	CCT	LUMEN OUTPUT	CRI	BEAM ANGLE	IP	IK	WARRANTY
AVE-S12-40	12W	4	4000	1280	>70	40°	IP65	IK08	5 year
AVE-M23-40	23W	9	4000	2650	>70	40°	IP65	IK08	5 year

A stylish round ceiling light available in three sizes and rated to IP65 for outdoor use. Tempered glass lenses offer security.

- Die-cast aluminium construction with fast installation design.
- Super white tempered glass lens and inbuilt reflector offering high visual comfort and even light distribution.
- UV protected pure polyester powder coated housing offering high corrosion resistance.
- High quality LED chips and driver.
- RAL9005, other RAL colours available on request.



**CAS-S9**



CAS-S



**CAS-M15**

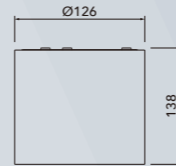

CAS-M



**CAS-L36**

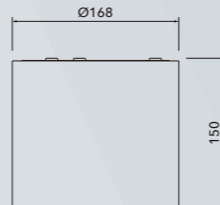

CAS-L



CODE	POWER	LED PCS	CCT	LUMEN OUTPUT	CRI	BEAM ANGLE	IP	IK	WARRANTY
CAS-S9-80	9W	1	4000	770	>70	80°	IP65	IK08	5 year
CAS-M15-80	15W	1	4000	1450	>70	80°	IP65	IK08	5 year
CAS-L36-80	36W	1	4000	3730	>70	80°	IP65	IK08	5 year



A decorative and highly versatile ceiling light in die-cast aluminium with impact resistant polycarbonate diffuser. Ideal for canopies and courtyards.

- Die-cast aluminium construction.
- Impact resistant opal polycarbonate diffuser offering high visual comfort and even light distribution.
- UV protected pure polyester powder coated housing offering high corrosion resistance.
- High quality LED chips and driver.
- RAL9007, other RAL colours available on request.



 **CIL-25**

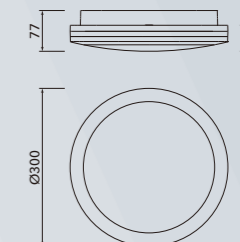

CIL



CODE	POWER	LED PCS	CCT	LUMEN OUTPUT	CRI	BEAM ANGLE	IP	IK	WARRANTY
CIL-25-100	25W	108	4000	2400	>70	100°	IP65	IK08	5 year

A modern and stylish update to traditional bulkheads, available in two sizes and two finishes. Ideal for use inside or outdoors, impact resistant with anti-tamper screws.

- Polycarbonate base, diffuser and trim rated to IK10 impact resistance.
- UV resistant opal polycarbonate diffuser offering high visual comfort and even light distribution.
- Adjustable CCT to suit a variety of applications.
- High quality LED chips and driver and available with integrated emergency.
- M20 entry holes on sides and rear.

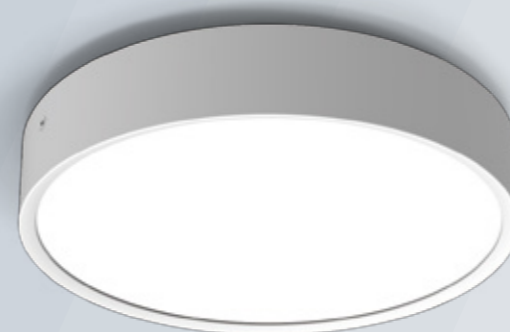

ESP-15-WH



ESP-15-BK

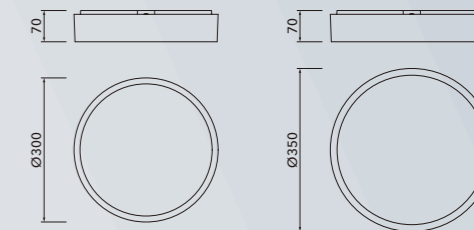

ESP



CODE	POWER	LED PCS	CCT	LUMEN OUTPUT	CRI	BEAM ANGLE	IP	IK	WARRANTY
ESP-15-110-WH	15W	364	3000/4000	1500/1500	>80	110°	IP65	IK10	5 year
ESP-15-110-BK	15W	364	3000/4000	1500/1500	>80	110°	IP65	IK10	5 year
ESP-15-110-WH-EM	15W	364	3000/4000	1500/1500	>80	110°	IP65	IK10	5 year
ESP-15-110-BK-EM	15W	364	3000/4000	1500/1500	>80	110°	IP65	IK10	5 year
ESP-25-110-WH	25W	476	3000/4000	2500/2500	>80	110°	IP65	IK10	5 year
ESP-25-110-BK	25W	476	3000/4000	2500/2500	>80	110°	IP65	IK10	5 year
ESP-25-110-WH-EM	25W	476	3000/4000	2500/2500	>80	110°	IP65	IK10	5 year
ESP-25-110-BK-EM	25W	476	3000/4000	2500/2500	>80	110°	IP65	IK10	5 year



## WALL WASH

Linear wall wash luminaires ideal for illuminating building facades.



### DUBLINA

P150

Power	12-36W
CCT	4000/RGBW
Lumen Output	936-4980



### PRAGA

P152

Power	7-18W
CCT	3000/4000/RGBW
Lumen Output	504-1494

A linear wall wash light available in two lengths and in fixed colour and RGBW options. Ideal for illuminating building facades and other structures such as bridges.

- Extruded aluminium body with die-cast aluminium end caps and silicon gaskets for high IP rating.
- Super white tempered glass, with high visual comfort and uniform light distribution.
- UV protected pure polyester powder coated housing offering high corrosion resistance.
- Wall and ceiling mounting with adjustable mounting brackets.
- High quality LED chips and driver. Fixed colour and RGBW available with DMX control.
- Each luminaire is supplied pre-wired for easy installation.
- All external screws are 304 stainless steel.
- RAL9007, other RAL colours available on request.

### Various mounting options

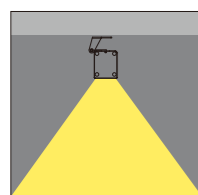

Ceiling-mounted.

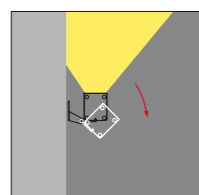

Wall-mounted uplighting with adjustable brackets.

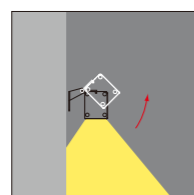

Wall-mounted downlighting with adjustable brackets.

CODE	POWER	LED PCS	CCT	LUMEN OUTPUT	CRI	BEAM ANGLE	IP	IK	WARRANTY
DUB-S12-1040	12W	6	4000	1044	>70	10°40°	IP67	IK08	5 year
DUB-S12-1040-RGBW	12W	6	RGBW	936	>70	10°40°	IP67	IK08	5 year
DUB-M36-1040	36W	18	4000	3168	>70	10°40°	IP67	IK08	5 year
DUB-M36-1040-RGBW	36W	18	RGBW	2700	>70	10°40°	IP67	IK08	5 year
DUB-L60-1040	60W	28	4000	4980	>70	10°40°	IP67	IK08	5 year
DUB-L60-1040-RGBW	60W	28	RGBW	4380	>70	10°40°	IP67	IK08	5 year



**DUB-M36**

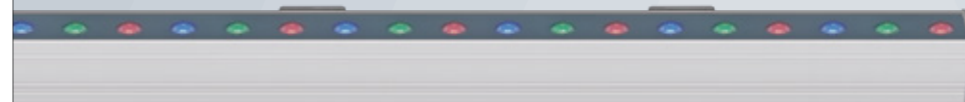

**DUB-L60-RGBW**

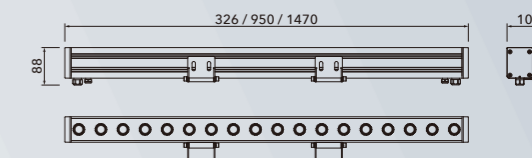

DUB



A linear wall wash light available in two lengths and in fixed colour and RGBW options. Ideal for illuminating building facades and other structures such as bridges.

- Extruded aluminium body with die-cast aluminium end caps and silicon gaskets for high IP rating.
- Super white tempered glass, with high visual comfort and uniform light distribution.
- UV protected pure polyester powder coated housing offering high corrosion resistance.
- Wall and ceiling mounting with adjustable mounting brackets.
- High quality LED chips and driver. Fixed colour and RGBW available with DMX control.
- Each luminaire is supplied pre-wired for easy installation.
- All external screws are 304 stainless steel.
- RAL9007, other RAL colours available on request.



### Various mounting options

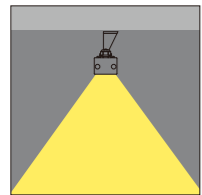

Ceiling-mounted.

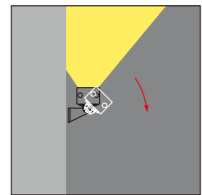

Wall-mounted uplighting with adjustable brackets.

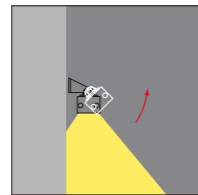

Wall-mounted downlighting with adjustable brackets.

CODE	POWER	LED PCS	CCT	LUMEN OUTPUT	CRI	BEAM ANGLE	IP	IK	WARRANTY
PRA-7-1550-RGBW	7W	8	RGBW	504	>70	15°50°	IP67	IK08	5 year
PRA-12-1550	12W	12	3000/4000	936	>70	15°50°	IP67	IK08	5 year
PRA-12-1550-RGBW	12W	12	RGBW	900	>70	15°50°	IP67	IK08	5 year
PRA-18-1550	18W	18	3000/4000	1494	>70	15°50°	IP67	IK08	5 year
PRA-18-1550-RGBW	18W	18	RGBW	1314	>70	15°50°	IP67	IK08	5 year



▶ **PRA-12**

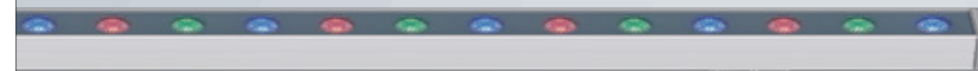

▶ **PRA-18-RGBW**

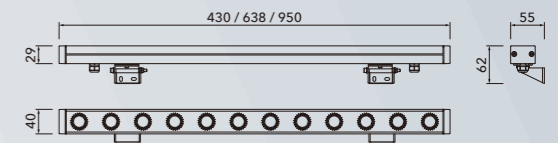

PRA





## INGROUND

A range of high quality inground lighting for discreet and effective uplighting applications.



**IBERIA**  
P156



**ANGLIA**  
P158

Power	16-80W	7-21W
CCT	4000/RGBW	4000
Lumen Output	1360-5520	230-730



**HIBERNIA**  
P160



**PARTHIA**  
P162

Power	9-23W	6W
CCT	4000	3000
Lumen Output	500-1300	200



**HELVETIA**  
P164



**LECHIA**  
P166

Power	1-2W	6-10W
CCT	3000	4000
Lumen Output	14-34	140-320



▶ **IBE-16**



▶ **IBE-80-RGBW**

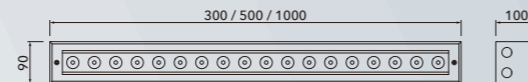

IBE

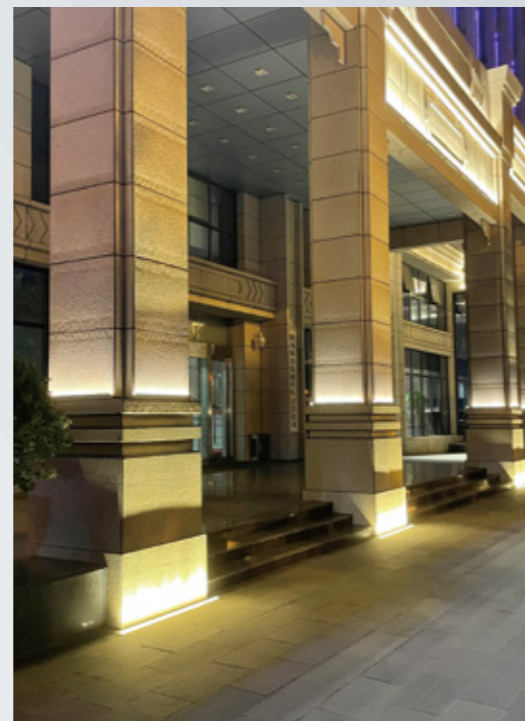

A high output and inground linear wall wash light available in three lengths and in fixed colour and RGBW options offering versatility for a range of applications.

- Extruded aluminium body with die-cast aluminium end caps and silicon gaskets for high IP rating.
- 304 grade stainless steel cover plate and in ground sleeve. Luminaire can withstand weight of 5000kg.
- Super white tempered glass, with high visual comfort and uniform light distribution.
- High quality LED chips, and DC 24V input for fixed output and DMX control options.
- Specially designed optics ideal for wall washing applications.
- All external screws are 304 stainless steel.



L=300mm / P=16W



L=500mm / P=32W



L=1000mm / P=65W



**Accessories**



Honeycomb louvre

CODE	POWER	LED PCS	CCT	LUMEN OUTPUT	CRI	BEAM ANGLE	IP	IK	WARRANTY
IBE-16-L30	16W	6	4000	1360	>80	TE13	IP66	IK09	5 year
IBE-20-L30-RGBW	20W	6	4000	1260	>80	TE13	IP66	IK09	5 year
IBE-32-L50	32W	12	4000	2720	>80	TE13	IP66	IK09	5 year
IBE-40-L50-RGBW	40W	12	4000	2480	>80	TE13	IP66	IK09	5 year
IBE-65-L100	65W	24	4000	5520	>80	TE13	IP66	IK09	5 year
IBE-80-L100-RGBW	80W	24	4000	5200	>80	TE13	IP66	IK09	5 year

High quality inground luminaire available in two sizes and suitable for a range of applications including uplighting of buildings and objects as well as generic open areas as walkover lights.

- 304 grade stainless steel housing and installation sleeve.
- Crystal clear 10mm tempered glass cover, the luminaire can withstand loads of 5000kg.
- Specially designed optics for optimum light distribution and low glare.
- Simple snap-in installation with hidden connections.
- Oil and water resistant with anti-slip glass.
- High quality LED chips, and DC 24V input for fixed output and DMX control options.
- All external screws are 304 stainless steel.

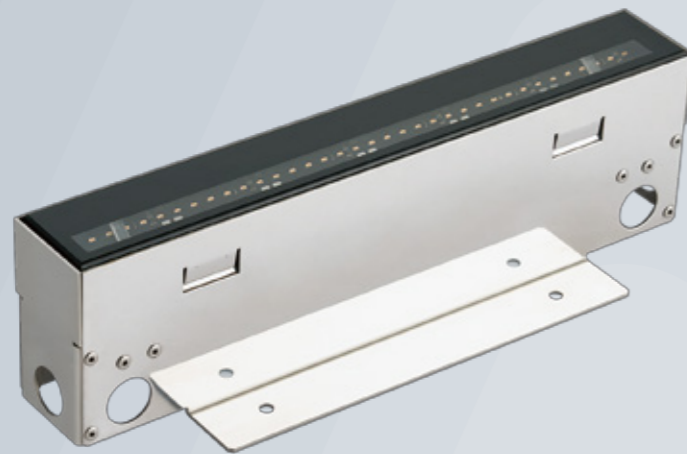

ANG-7

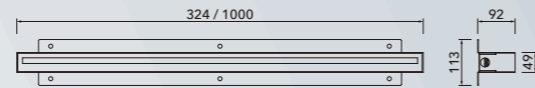

ANG

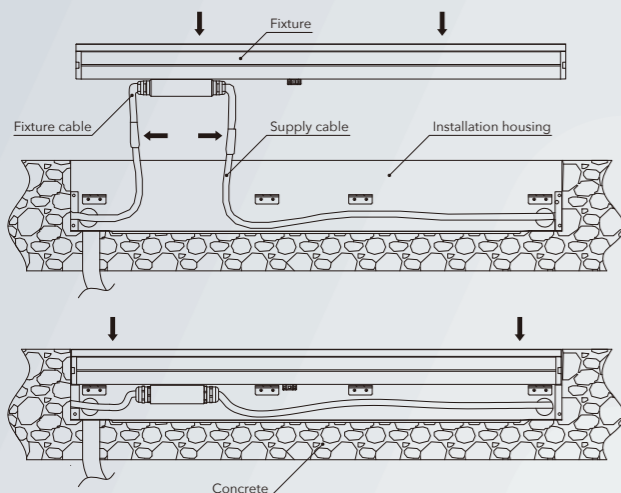

L=324mm / P=7W



L=1000mm / P=21W

CODE	POWER	LED PCS	CCT	LUMEN OUTPUT	CRI	BEAM ANGLE	IP	IK	WARRANTY
ANG-7-L32	7W	36	4000	230	>70	100°	IP67	IK09	5 year
ANG-21-L100	21W	114	4000	730	>70	100°	IP67	IK09	5 year



High quality inground luminaire available in two sizes and suitable for a range of applications including uplighting of buildings and objects as well as generic open areas as walkover lights.



**HIB-9**

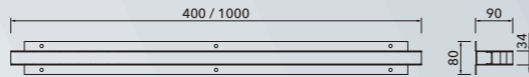
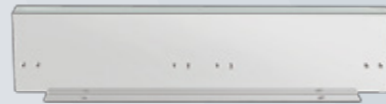

**HIB**

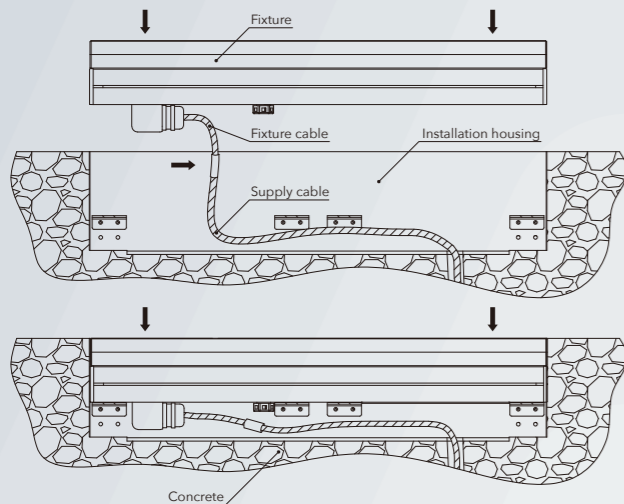

L=400mm / P=9W



L=1000mm / P=23W

- 304 grade stainless steel housing and installation sleeve.
- Crystal clear 10mm tempered glass cover, the luminaire can withstand loads of 5000kg.
- Specially designed optics for optimum light distribution and low glare.
- Simple snap-in installation with hidden connections.
- Oil and water resistant with anti-slip glass.
- High quality LED chips, and DC 24V input for fixed output and DMX control options.
- All external screws are 304 stainless steel.

CODE	POWER	LED PCS	CCT	LUMEN OUTPUT	CRI	BEAM ANGLE	IP	IK	WARRANTY
HIB-9-L40	9W	49	4000	500	>70	120°	IP68	IK10	5 year
HIB-23-L100	23W	126	4000	1300	>70	120°	IP68	IK10	5 year

A high quality and impact resistant inground square luminaire with a specially designed wall wash optic and stainless steel construction.

- 304 grade stainless steel body with 304 stainless steel and ABS installation housing.
- Clear 15mm tempered glass which can withstand loads of 5000kg.
- Specially designed optics with wall wash distribution.
- Simple snap-in installation with hidden connections.
- Oil and water resistant with anti-slip glass.
- High quality LED chips, and DC 24V input.
- All external screws are 304 stainless steel.



CODE	POWER	LED PCS	CCT	LUMEN OUTPUT	CRI	BEAM ANGLE	IP	IK	WARRANTY
PAR-6	6W	2	3000	200	>70	30°×45° Tilt 15°	IP68	IK10	5 year



**PAR-6**

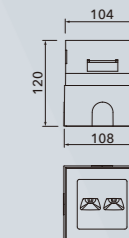

PAR

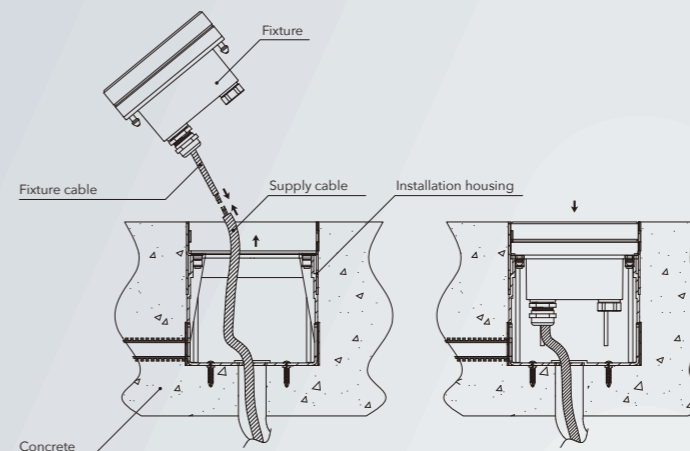

A range of high quality inground luminaires with unilateral and bidirectional light source options.

- Die-cast aluminium construction with high quality polycarbonate diffuser.
- Single and double light source options with even light distribution.
- Durable plastic installation housing with waterproof silicon sealing rings.
- Simple snap-in installation with hidden connections.
- High quality LED chips, and DC 24V input.
- All external screws are 304 stainless steel.
- RAL9007, other RAL colours available on request.



**HEL-01**

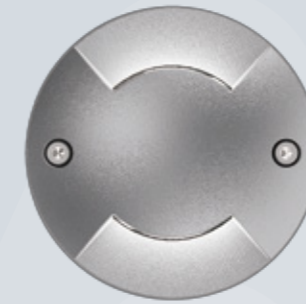

**HEL-02**



**HEL-03**

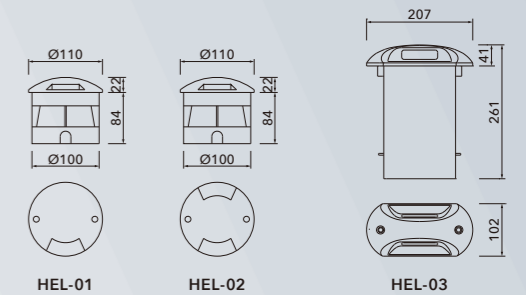

HEL

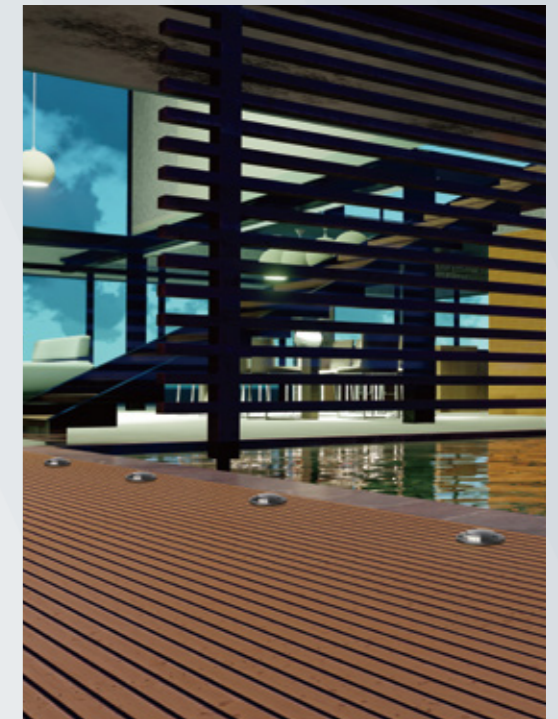

CODE	POWER	LED PCS	CCT	LUMEN OUTPUT	CRI	BEAM ANGLE	IP	IK	WARRANTY
HEL-01	1W	4	3000	14	>70	120°	IP67	IK09	5 year
HEL-02	2W	8	3000	34	>70	120°	IP67	IK09	5 year
HEL-03	1W	16	3000	14	>70	120°	IP67	IK09	5 year

A high quality and impact resistant range of inground luminaires manufactured from stainless steel with specially designed optics for wall washing and uplighting applications.

- 304 grade stainless steel front and installation housing with pure aluminium body.
- Clear 10mm tempered glass which can withstand loads of 2000kg.
- Wall wash version with a tiltable light source and a general uplight option.
- Simple snap-in installation with hidden connections.
- Oil and water resistant with anti-slip glass.
- High quality LED chips, and DC 24V input.
- All external screws are 304 stainless steel.

**Adjustable light angle**

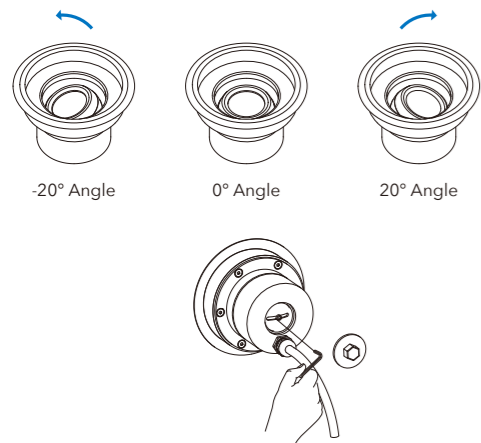

CODE	POWER	LED PCS	CCT	LUMEN OUTPUT	CRI	BEAM ANGLE	IP	IK	WARRANTY
LEC-6A	6W	1	4000	140	>70	30°x45° Tilt 15°	IP68	IK10	5 year
LEC-6B	6W	1	4000	320	>70	30°	IP68	IK10	5 year
LEC-10	10W	1	4000	240	>70	30°	IP68	IK10	5 year

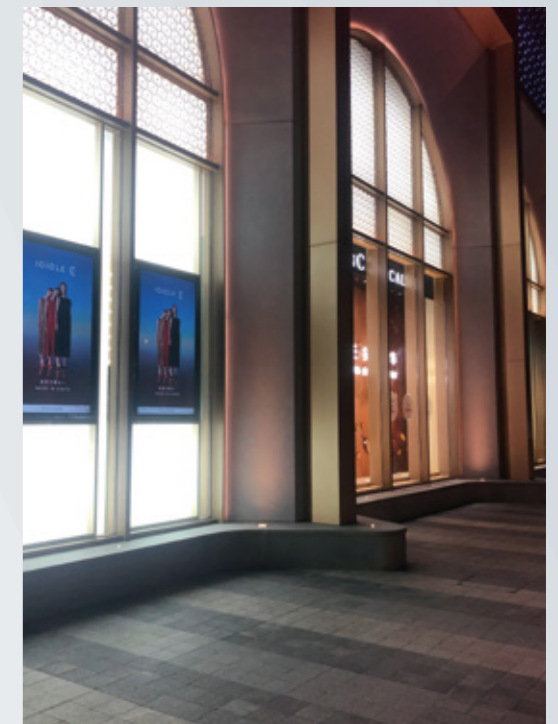
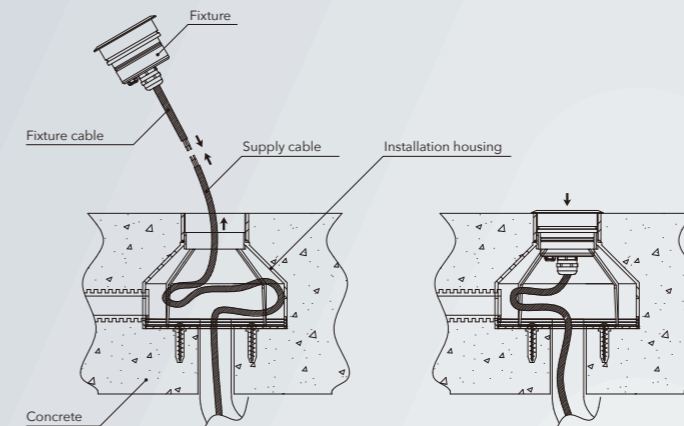
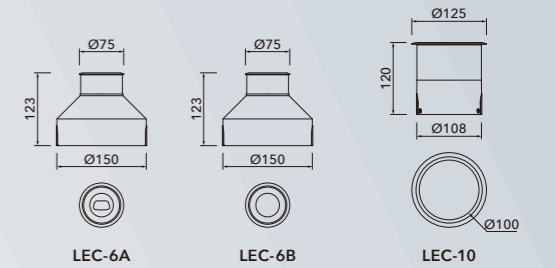
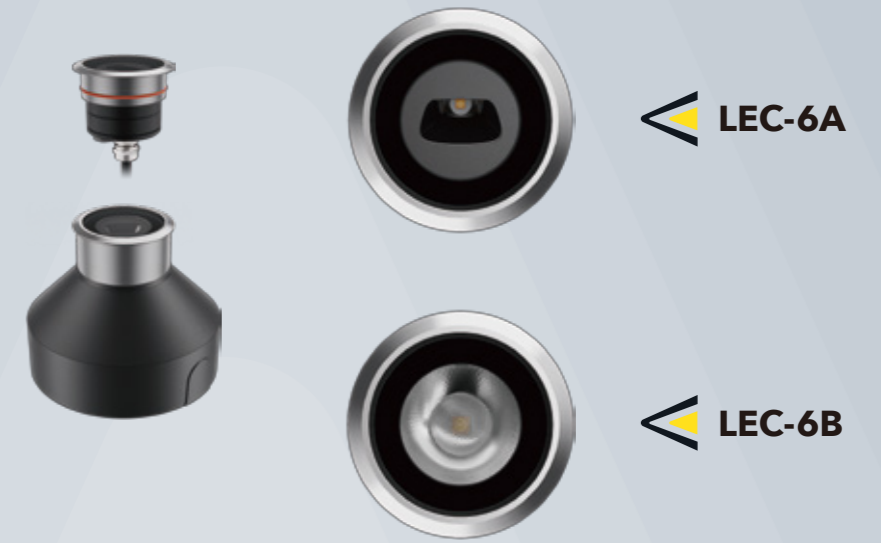



## INDUSTRIAL

A range of luminaires suitable for industrial applications such as warehouses, factories and logistics environments.



**SALACIA**

P170

Power	18-50W
CCT	4000
Lumen Output	2800-6900



**EGARA**

P172

Power	65-150W
CCT	4000
Lumen Output	11700-27000

A sleek yet robust non-corrosive fitting with opal polycarbonate diffuser and stainless steel clips, ideal for back of house areas and mezzanine floors.

- Polycarbonate base and opal polycarbonate diffuser.
- UV stabilised and IK08 impact rating.
- Stainless steel clips and surface mounting brackets with eyelets to allow suspension.
- High quality LEDs and driver. Integral emergency options also available.
- 20mm conduit entry points at each end and on base.

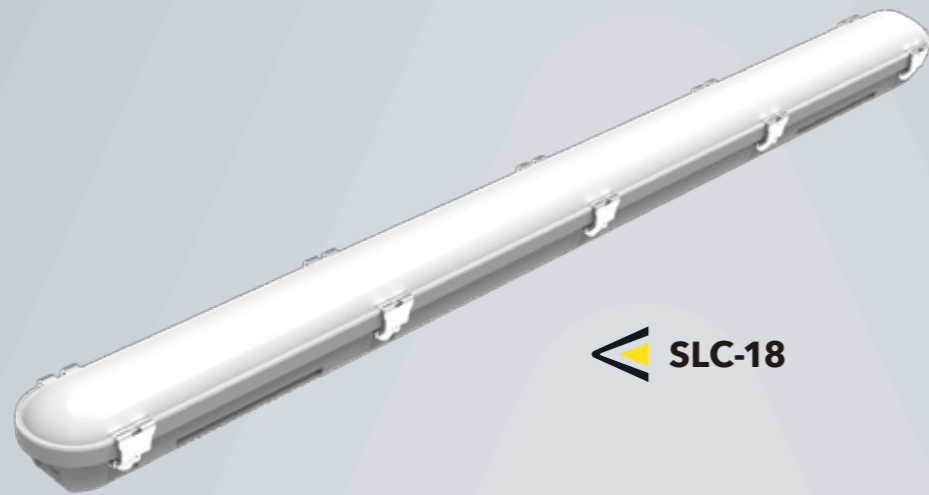

**SLC-18**

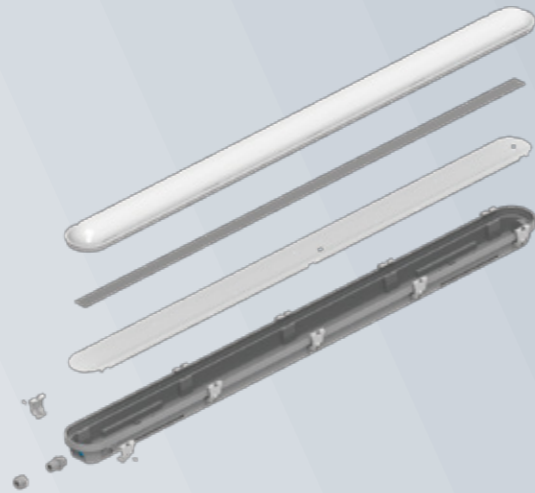

SLC



CODE	POWER	LED PCS	CCT	LUMEN OUTPUT	CRI	BEAM ANGLE	IP	IK	WARRANTY
SLC-18-120	18W	72	4000	2800	>80	110°	IP65	IK08	5 year
SLC-18-120-EM									
SLC-38-120	38W	102	4000	5000	>80	110°	IP65	IK08	5 year
SLC-38-120-EM									
SLC-30-150	30W	135	4000	4100	>80	110°	IP65	IK08	5 year
SLC-30-150-EM									
SLC-50-150	50W	230	4000	6900	>80	110°	IP65	IK08	5 year
SLC-50-150-EM									

High performance highbay available in two sizes with selectable outputs to suit different applications and installation heights, with an optional plug and play PIR sensor. Ideal for warehouses and factories.

- Die-cast aluminium construction with separate driver housing.
- Polycarbonate diffuser with integrated lens to offer effective light distribution.
- High quality LED chips and driver.
- Integrated suspension hook for use with jack chain or steel wire.
- RAL9005, other RAL colours available on request.
- Plug and play PIR sensor available which is programmable from floor level using remote controls.



▶ **EGA-110**



▶ **EGA-150**



Accessories



PIR sensor

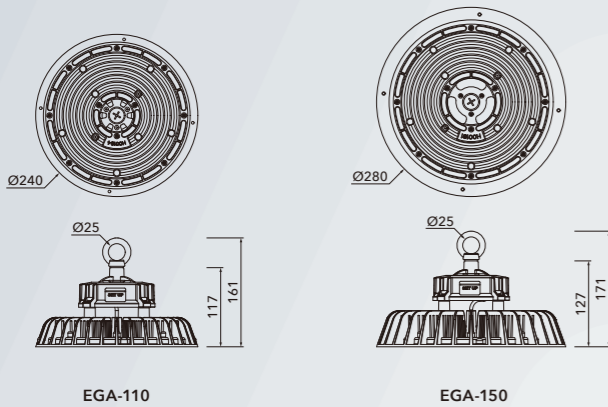

EGA-110

EGA-150

EGA

CODE	POWER	CCT	LUMEN OUTPUT	CRI	BEAM ANGLE	IP	IK	WARRANTY
EGA-110-120	65-110W	4000	11700-19800	>80	120°	IP65	IK08	5 year
EGA-150-120	90-150W	4000	16200-27000	>80	120°	IP65	IK08	5 year

# LEDSCAPE®

THE POWER OF LIGHT

